

MADE IN ITALY. MADE TO EXCEL.

BOOST MINERAL

Interactive version

STONE LOOK

PORCELAIN TILES
GRES PORCELLANATO
Grès cérame
Feinsteinzeug
Gres porcelánico
Керамический гранит



Atlas Concorde is one of the leading global brands in the production of ceramic tiles and large slabs for design and architecture. With over 50 years of history, two production plants, and numerous showrooms in the capitals of international design, Atlas Concorde offers integrated and sustainable ceramic systems for floors, walls, outdoor spaces, worktops, bathroom furnishings, facades and special projects. Design your world with Atlas Concorde.

Atlas Concorde è uno dei principali brand mondiali nella produzione di superfici e grandi lastre ceramiche per il design e l'architettura. Con oltre cinquant'anni di storia, due stabilimenti produttivi, numerose showroom nelle capitali della progettazione internazionale, offriamo sistemi ceramici integrati e sostenibili per pavimenti, rivestimenti, outdoor, piani di lavoro, arredo bagno, facciate e progetti speciali. Design your world with Atlas Concorde.

atlasconcorde.com



INDEX



THE INSPIRATION >

IMAGE GALLERY >

SURFACE RANGE & TECHNICAL SPECIFICATIONS >

ENJOY THE VIDEO



Index

- ↔ **The Inspiration**
- ↔ **Image Gallery**
- ↔ BOOST MINERAL WHITE
- ↔ BOOST MINERAL PEARL
- ↔ BOOST MINERAL GREY
- ↔ BOOST MINERAL SMOKE
- ↔ BOOST MINERAL TARMAC
- ↔ **Surface Range & Technical Specification**

THE INSPIRATION >

IMAGE GALLERY >

SURFACE RANGE & TECHNICAL SPECIFICATIONS >

ENJOY THE VIDEO



The essence of a unique stone

Drawn over the centuries from ore, volcanic ash and slate, the Belgian Ardennes stone is the source of inspiration for the collection.

Disegnata nel corso dei secoli da minerali, cenere vulcanica e ardesia, la pietra belga delle Ardenne è la fonte di ispirazione della collezione.

Façonnée au cours des siècles par des minéraux, de la cendre volcanique et de l'ardoise, la pierre belge des Ardennes est la source d'inspiration de la collection.

Das belgische Gestein der Ardennen, das im Laufe der Jahrhunderte aus Erzen, Vulkanasche und Schiefer gewonnen wurde, ist die Inspirationsquelle für die Kollektion.

Moldeada a lo largo de los siglos a partir de minerales, ceniza volcánica y pizarra, la piedra belga de las Ardenas es la fuente de inspiración de la colección.

Источником вдохновения для коллекции стал камень из бельгийских Арденн, который представляет собой вековые наслоения минералов, вулканического пепла и сланца.

THE INSPIRATION >

IMAGE GALLERY >

SURFACE RANGE & TECHNICAL SPECIFICATIONS >

ENJOY THE VIDEO



Inner nature

An authentic and modern stone effect combining indoor and outdoor. Boost Mineral crystallises the naturalness of Belgian Ardennes stone on the ceramic surface.

Un effetto pietra autentico e moderno in dialogo tra interno ed esterno. Boost Mineral cristallizza la naturalezza della pietra delle Ardenne sulla superficie ceramica.

Effet pierre authentique et moderne, liaison entre intérieur et extérieur. Boost Mineral cristallise l'aspect naturel de la pierre des Ardennes sur la surface céramique.

Eine authentische und moderne Steinoptik im Dialog zwischen Innen- und Außenbereich. Boost Mineral kristallisiert die Natürlichkeit des Ardennen Steins auf der Keramikoberfläche.

Un efecto piedra auténtico y moderno que establece un diálogo entre interior y exterior. Boost Mineral cristaliza la naturalidad de la piedra de las Ardenas sobre la superficie cerámica.

Аутентичный и современный эффект камня на стыке помещений и улицы. Boost Mineral кристаллизует натуральность арденнского камня на керамической поверхности.

THE INSPIRATION >

IMAGE GALLERY >

SURFACE RANGE & TECHNICAL SPECIFICATIONS >

ENJOY THE VIDEO

Fine grains and delicate shades

The lightly brush-hammered surface reveals all the details of the inspiration stone: compact background colour, fine and homogeneous grain, mineral crystals, and almost imperceptible fine veins.

La superficie leggermente bocciardata rivela tutti i dettagli della pietra di ispirazione: colore di fondo compatto, grana fine ed omogenea, cristalli minerali, e vene sottili quasi impercettibili.

La surface légèrement bouchardée révèle tous les détails de la pierre dont elle s'inspire : couleur du fond compacte, grain fin et homogène, cristaux minéraux et veines fines presque imperceptibles.

Die leicht gehämmerte Oberfläche offenbart alle Details des Inspirationssteins: kompakte Grundfarbe, feine und homogene Maserung, Mineralkristalle und kaum wahrnehmbare feine Maserungen.

La superficie ligeramente abujardada revela todos los detalles de la piedra en la que se inspira: color de fondo compacto, grano fino y homogéneo, cristales minerales y finas vetas casi imperceptibles.

Слегка бучардированная поверхность обладает всеми деталями исходного камня: плотный цвет фона, мелкое и однородное зерно, минеральные кристаллы и тонкие, почти незаметные прожилки.

THE INSPIRATION >

IMAGE GALLERY >

SURFACE RANGE & TECHNICAL SPECIFICATIONS >

ENJOY THE VIDEO ▶

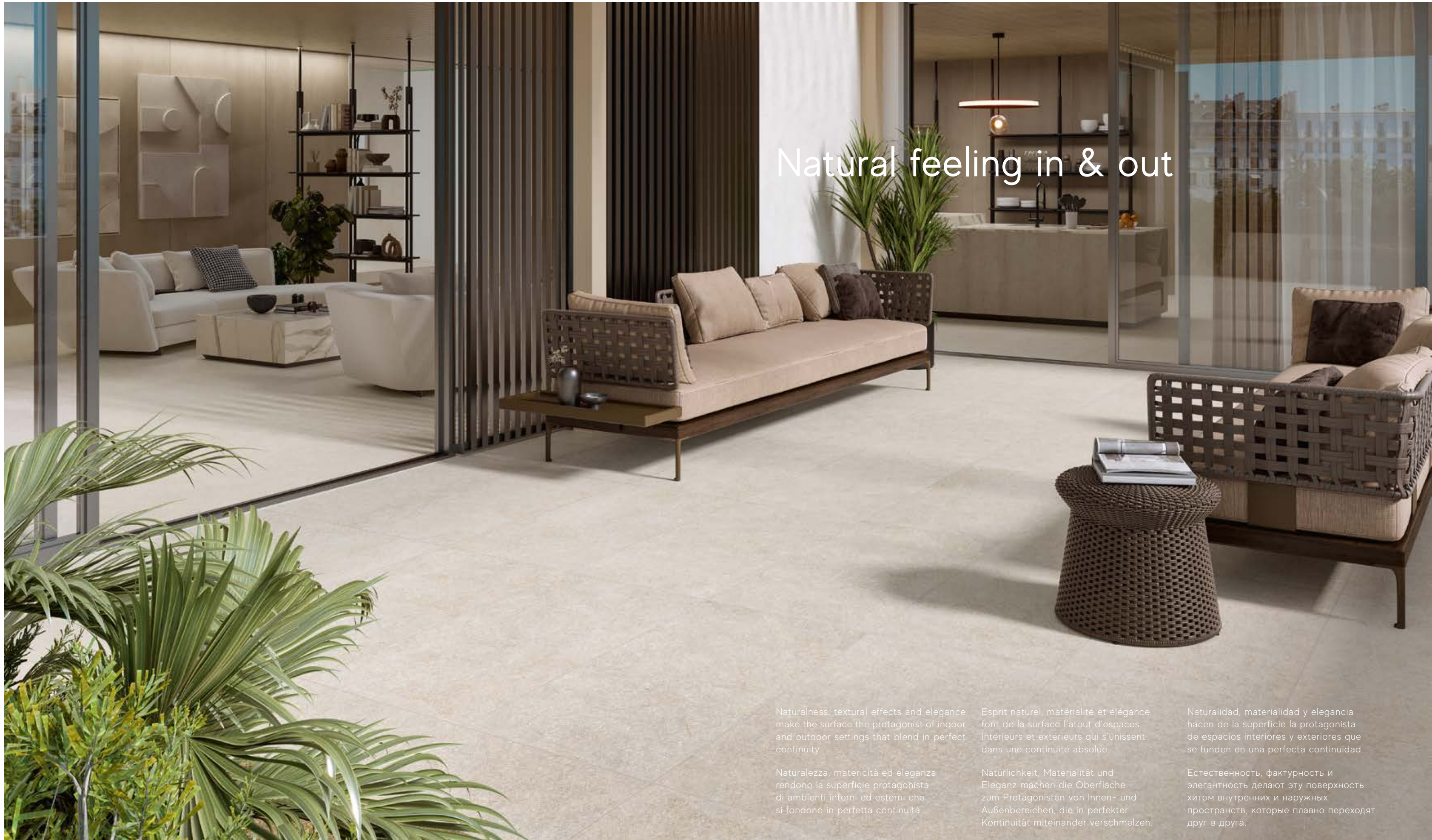

Natural feeling in & out

Naturalness, textural effects and elegance make the surface the protagonist of indoor and outdoor settings that blend in perfect continuity.

Naturalzza, matericità ed eleganza rendono la superficie protagonista di ambienti interni ed esterni che si fondono in perfetta continuità.

Esprit naturel, matérialité et élégance font de la surface l'atout d'espaces intérieurs et extérieurs qui s'unissent dans une continuité absolue.

Natürlichkeit, Materialität und Eleganz machen die Oberfläche zum Protagonisten von Innen- und Außenbereichen, die in perfekter Kontinuität miteinander verschmelzen.

Naturalidad, materialidad y elegancia hacen de la superficie la protagonista de espacios interiores y exteriores que se funden en una perfecta continuidad.

Естественность, фактурность и элегантность делают эту поверхность хитом внутренних и наружных пространств, которые плавно переходят друг в друга.

THE INSPIRATION >

IMAGE GALLERY >

SURFACE RANGE & TECHNICAL SPECIFICATIONS >

ENJOY THE VIDEO



Essential surfaces for contemporary spaces

Balanced between richness of detail and naturalness of the surface, Boost Mineral creates a modern stone effect with discreet elegance, ideal in contemporary design settings.

In equilibrio tra ricchezza di dettagli e naturalezza della superficie, Boost Mineral dà vita ad un effetto pietra moderno dall'eleganza discreta, ideale in ambienti dal design attuale.

Équilibre parfait entre richesse des détails et aspect naturel de la surface, Boost Mineral crée un effet pierre moderne, d'une élégance discrète, idéale dans des espaces design actuels.

Ausgewogenes Verhältnis zwischen Detailreichtum und Natürlichkeit der Oberfläche, Boost Mineral schafft eine moderne Steinoptik mit diskreter Eleganz, die sich ideal für zeitgenössische Designumgebungen eignet.

Consiguiendo un equilibrio entre la variedad de detalles y la naturalidad de la superficie, Boost Mineral da vida a un moderno efecto piedra muy elegante que funciona perfectamente en ambientes con un diseño contemporáneo.

Баланс между богатством деталей и естественностью поверхности. Boost Mineral дает жизнь современному эффекту камня со сдержанной элегантностью. Идеальный выбор для актуальных интерьеров.

THE INSPIRATION >

IMAGE GALLERY >

SURFACE RANGE & TECHNICAL SPECIFICATIONS >

ENJOY THE VIDEO ▶

Impactful look

The large sizes are inspired by precious monolithic blocks of polished natural stone with soft surface and delicate relief. Ideal for covering large surfaces, furniture, kitchen tops and worktops.

I grandi formati si ispirano a pregiati blocchi monolitici di pietra naturale levigata con una superficie morbida e un rilievo delicato. Ideali per rivestire ampie superfici, arredi e piani cucina di lavoro.

Les grands formats s'inspirent de recherchés blocs monolithiques de pierre naturelle polie, avec une surface douce et un relief délicat. Parfaits pour revêtir dse grandes surfaces, des meubles et des plans de cuisine et de travail.

Die großen Formate sind von kostbaren monolithischen Blöcken aus poliertem Naturstein mit samter Oberfläche und zartem Relief inspiriert. Ideal zum Abdecken großer Flächen, Möbel, Küchen- und Arbeitsplatten.

Los grandes formatos se inspiran en preciosos bloques monolíticos de piedra natural pulida con una superficie suave y un relieve delicado. Ideal para revestir grandes superficies, mobiliario, encimeras de cocinas y superficies de trabajo.

Большие форматы вдохновлены роскошными монолитными блоками из полированного природного камня с мягкой поверхностью и изящным рельефом. Идеально для больших площадей, элементов мебели, рабочих и кухонных поверхностей.

THE INSPIRATION >

IMAGE GALLERY >

SURFACE RANGE & TECHNICAL SPECIFICATIONS >

ENJOY THE VIDEO 



White



Pearl



Grey



Smoke



Tarmac

THE INSPIRATION >

IMAGE GALLERY >

SURFACE RANGE & TECHNICAL SPECIFICATIONS >

ENJOY THE VIDEO



Sensitech
SAFE. SOFT. SMART.

THE INSPIRATION >

IMAGE GALLERY >

SURFACE RANGE & TECHNICAL SPECIFICATIONS >

ENJOY THE VIDEO >

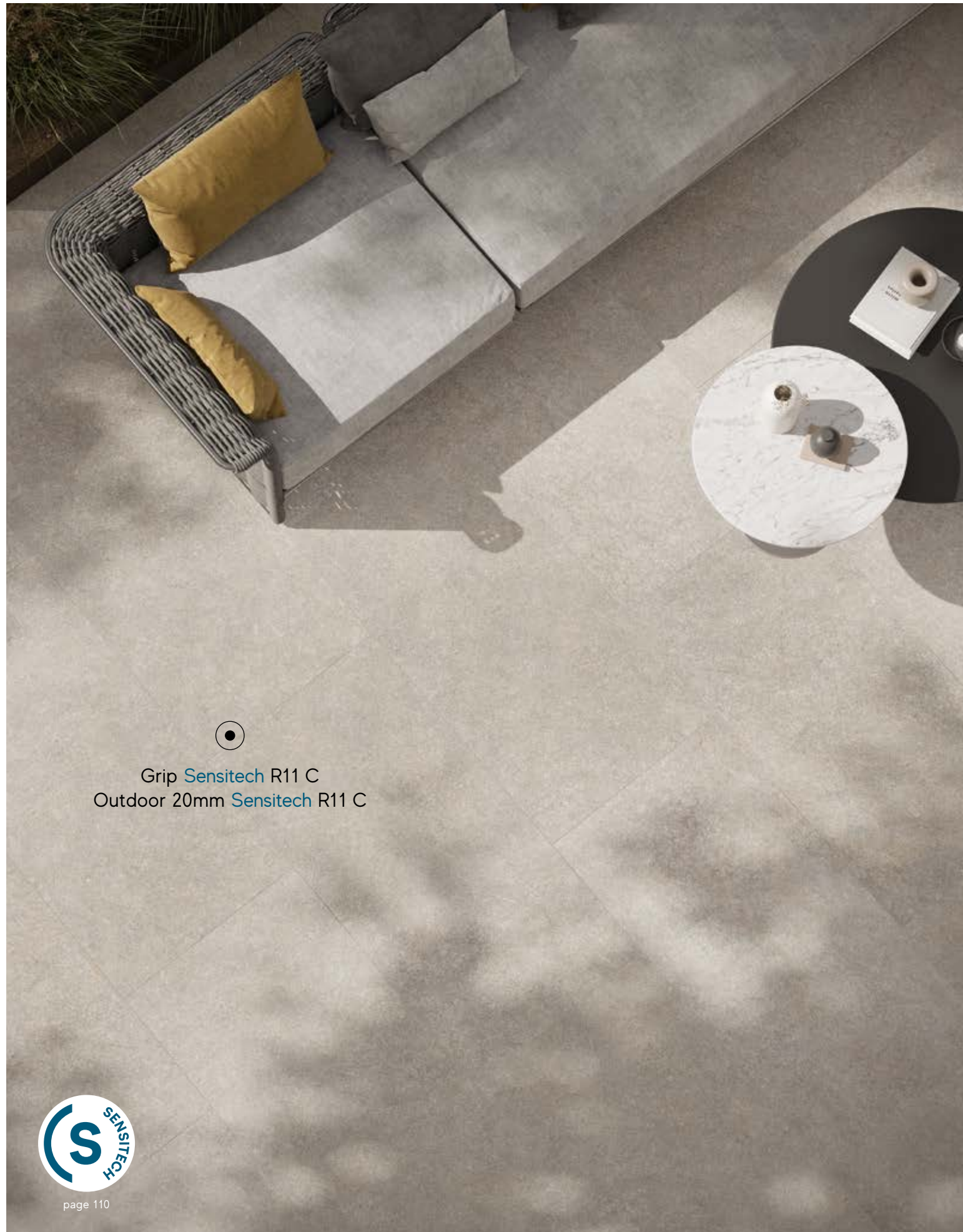

Grip [Sensitech R11 C](#)
Outdoor 20mm [Sensitech R11 C](#)



The evolution of ceramic surface

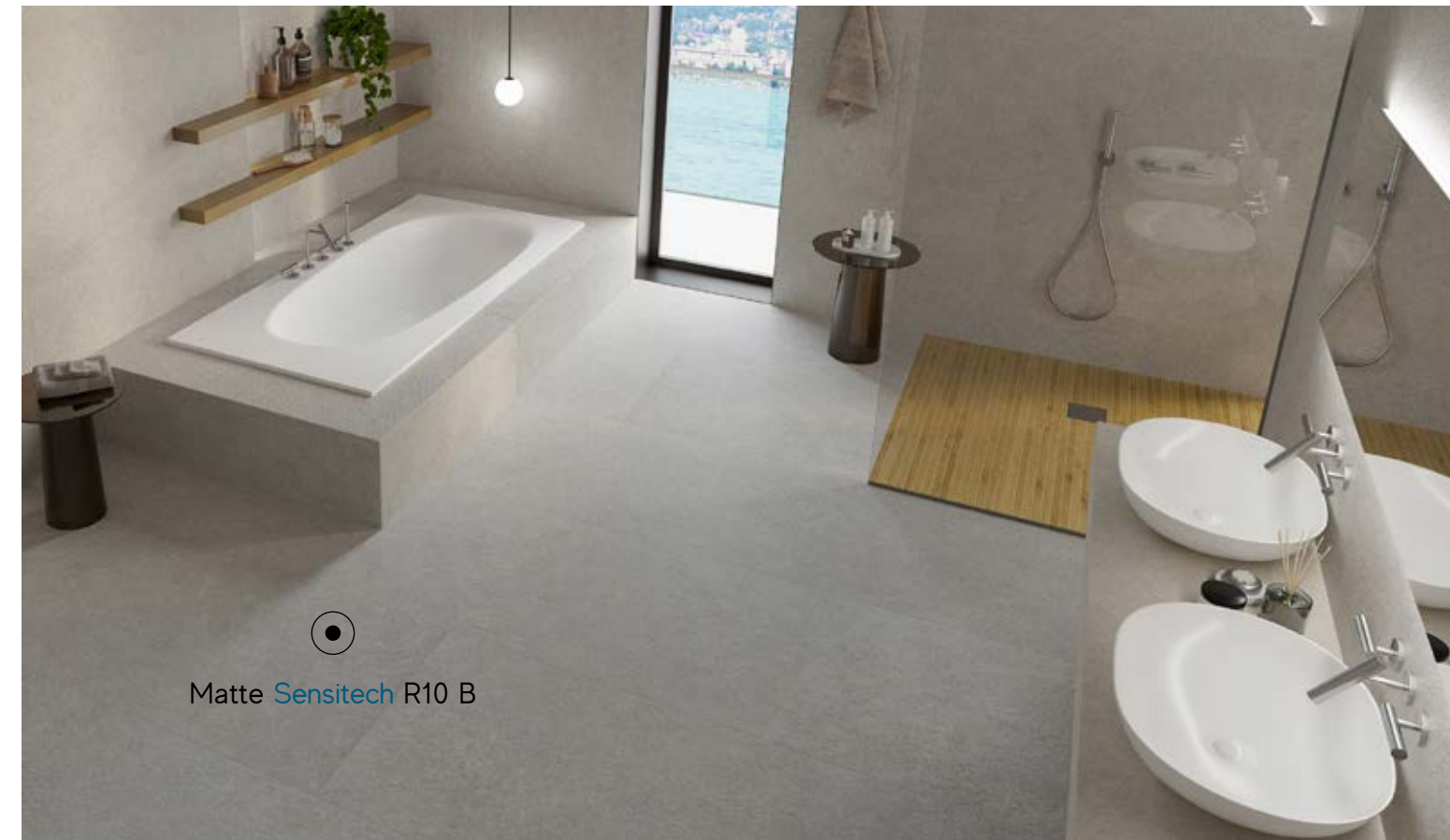

Matte [Sensitech R10 B](#)

Thanks to the Sensitech finish obtained using an Italian patented method, Atlas Concorde surfaces for interiors and exteriors combine high slip resistance with a surface that is pleasant to the touch and therefore also easier and quicker to clean.

Grazie alla finitura Sensitech, ottenuta con metodo brevettato in Italia, le superfici Atlas Concorde per interni ed esterni coniugano un'elevata resistenza allo scivolamento con una superficie piacevole al tatto, per questo anche più facile e veloce da pulire.

Grâce à la finition Sensitech, obtenue avec une méthode brevetée en Italie, les surfaces Atlas Concorde pour intérieur et extérieur associent une résistance au glissement élevée à un toucher agréable en devenant également plus faciles et rapides à nettoyer.

Dank des Finishes Sensitech, einem in Italien patentierten Verfahren, verbinden die Oberflächen von Atlas Concorde für den Innen- und Außenbereich eine hohe Rutschfestigkeit mit einer Oberfläche, die sich angenehm anfühlt und daher auch leichter und schneller zu reinigen ist.

Gracias al acabado Sensitech, obtenido con un método patentado en Italia, las superficies Atlas Concorde para interiores y exteriores combinan una alta resistencia al deslizamiento con un tacto agradable, lo que facilita y agiliza la limpieza.

Благодаря отделке Sensitech, полученной запатентованным в Италии методом, поверхности Atlas Concorde для помещений и улицы сочетают в себе высокую степень противоскольжения с приятной на ощупь и легко очищаемой поверхностью.

THE INSPIRATION >

IMAGE GALLERY >

SURFACE RANGE & TECHNICAL SPECIFICATIONS >

ENJOY THE VIDEO >



A (Boost) World of combinations



Boost Mineral is part of Boost World, a style project that combines a set of ceramic surfaces that are similar in style, look, and application. A global look that provides architects and designers with a complete tool for the design of any type of internal or external environment.

Boost Mineral si inserisce all'interno di Boost World, un progetto di stile che coniuga in un'unica prospettiva un insieme di superfici ceramiche affini per stile, look o aree di applicazione. Una proposta globale che fornisce ad architetti e designer uno strumento completo per la progettazione di ogni tipo di ambiente, interno ed esterno.

Boost Mineral s'insère à l'intérieur de Boost World, le projet de style qui conjugue, dans une même perspective, un ensemble de surfaces céramiques liées par une même affinité de style, d'aspect et de domaines d'application. Une proposition globale qui fournit aux architectes et aux designers un outil complet pour la conception de chaque type d'espace, en intérieur et en extérieur.

Boost Mineral ist Teil von Boost World, einem Stilprojekt, das in einer einheitlichen Stilperspektive eine Vielzahl an sich in Stil, Look oder Anwendungsbereich ähnelnde Keramikbeläge vereint. Ein globales Angebot, das Architekten und Designern ein rundum vollständiges Instrument für die Planung von Innen- und Außenbereichen aller Art bietet.

Boost Mineral forma parte de Boost World un proyecto de estilo que combina en una sola perspectiva un conjunto de superficies cerámicas similares en estilo, look o áreas de aplicación. Una propuesta integral que proporciona a los arquitectos y diseñadores una herramienta completa para el diseño de cualquier tipo de ambiente, tanto de interior como de exterior.

Boost Mineral является частью проекта Boost World – набора коллекций, сходных по стилю, внешнему виду и области применения. Проект предлагает архитекторам и дизайнерам комплексный инструмент для проектирования любого типа внутреннего или наружного пространства.

THE INSPIRATION >

IMAGE GALLERY >

SURFACE RANGE & TECHNICAL SPECIFICATIONS >

ENJOY THE VIDEO

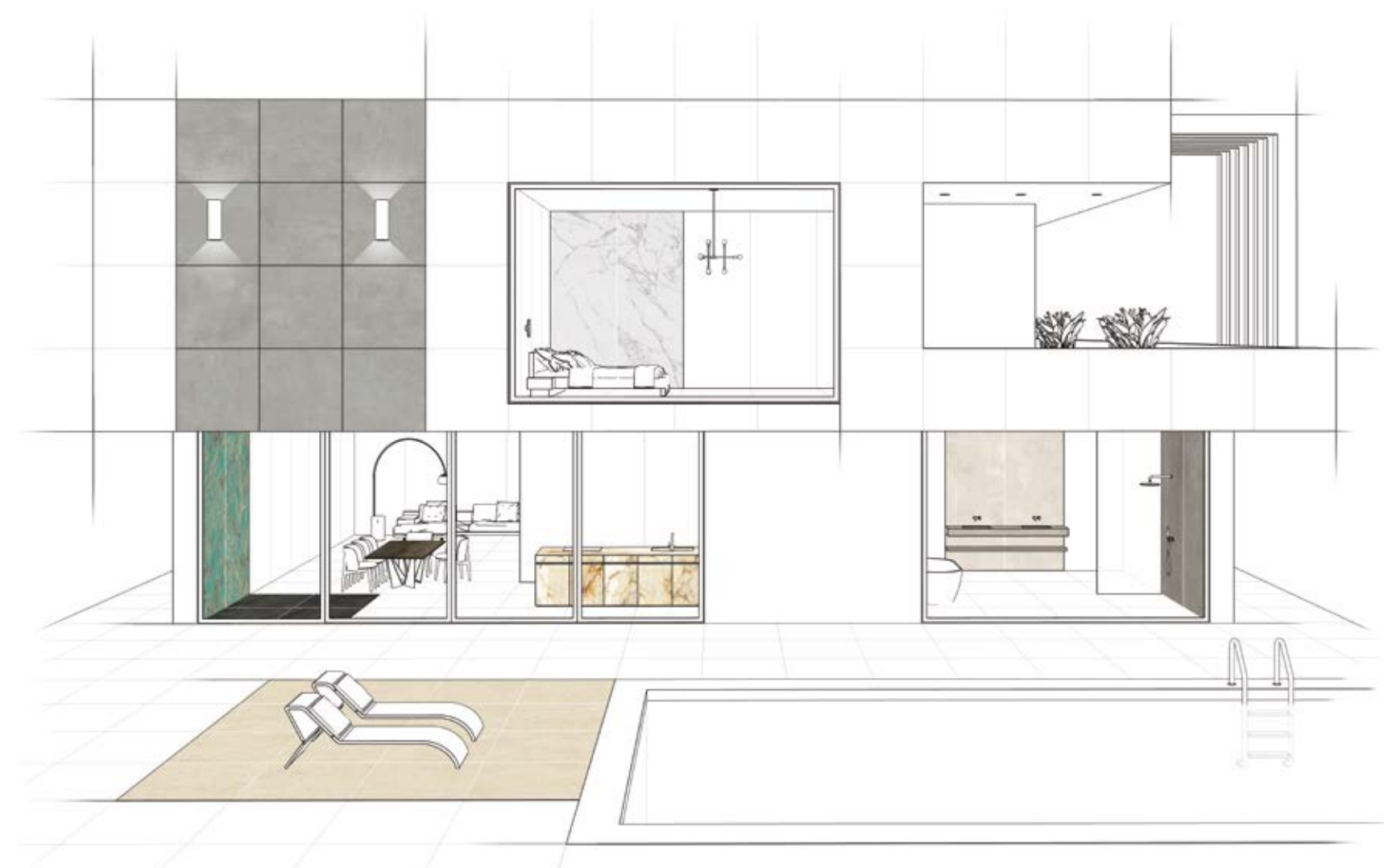
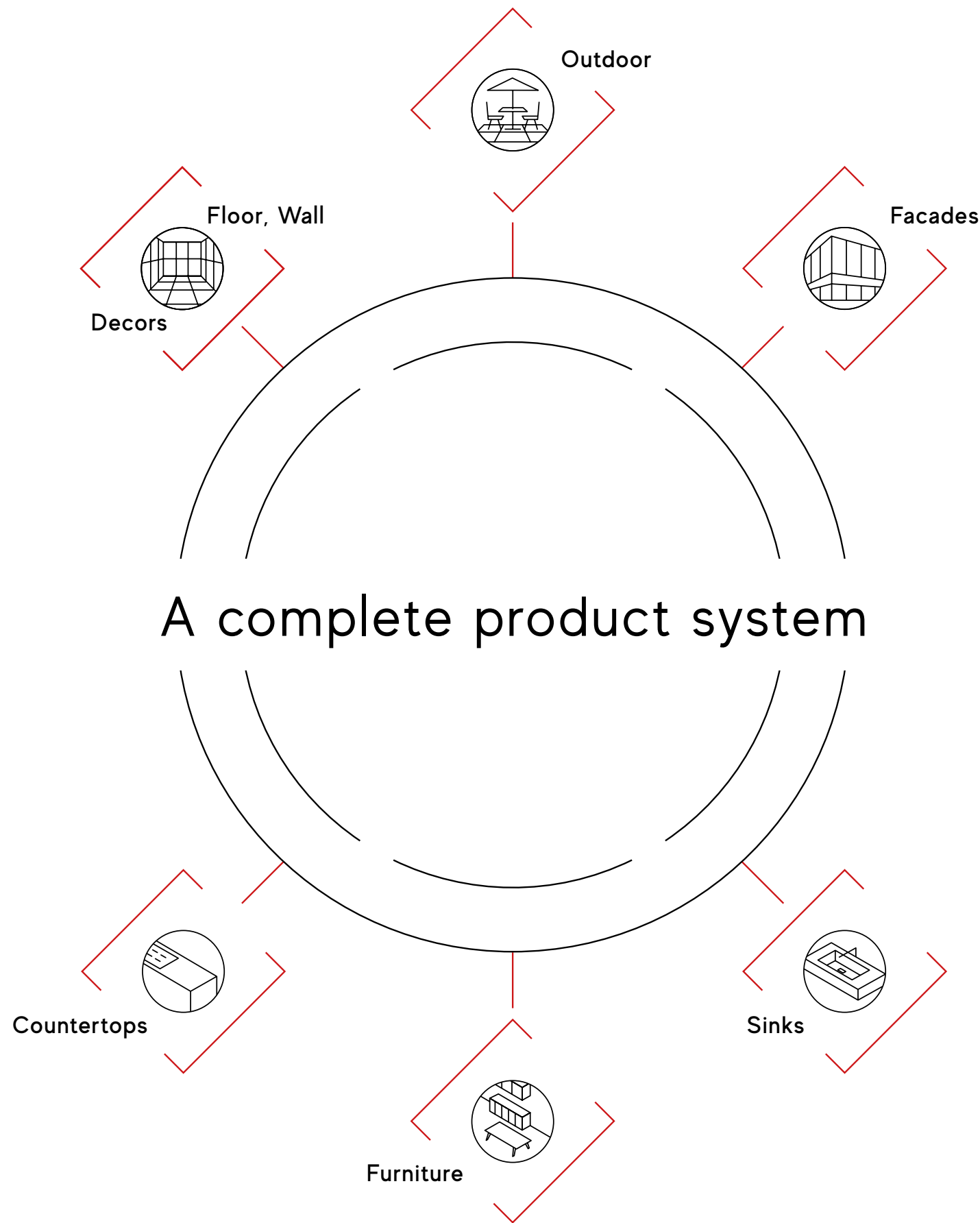

THE INSPIRATION >

IMAGE GALLERY >

SURFACE RANGE & TECHNICAL SPECIFICATIONS >

ENJOY THE VIDEO >

atlas concorde

A system of indoor and outdoor surfaces: floors, walls, and decors.

atlasPLAN

Large slabs for kitchen countertops, tables, and furnishings.

atlas concorde habitat

Washbasins and bathroom furnishings in combination with Atlas Concorde surfaces.

Our product system is designed to create complete, coordinated interiors and exteriors. With our brands we offer a stylistic selection of functional surfaces and products for every space.

Il nostro sistema di prodotto è pensato per realizzare ambienti completi e coordinati. Attraverso i nostri brand offriamo una proposta stilistica di superfici e prodotti funzionali per ogni spazio.

Notre système de produits est conçu pour créer des ambiances complètes et coordonnées. À travers nos marques, nous offrons une proposition stylistique de surfaces et de produits fonctionnels pour chaque espace.

Unser Produktsystem ist darauf ausgelegt, Räumlichkeiten komplett und koordiniert zu gestalten. Mit unseren Marken bieten wir stilistisch ansprechende Beläge und funktionelle Produkte für jedes Ambiente.

Nuestro sistema de productos está diseñado para crear ambientes completos y combinados. A través de nuestras marcas, ofrecemos una propuesta estilística de superficies y productos funcionales para todos los espacios.

Наша продуктовая система задумана для комплексного оформления интерьеров. Посредством наших брендов мы предлагаем широкий ассортимент функциональных изделий и плитки для любого пространства.

Image Gallery

↔ Elegant penthouse - White



↔ Scenic outdoor villa - White



↔ Refined open space villa - Pearl



↔ Sophisticated bathroom - Pearl



↔ Emotional in & out living - Grey



↔ Contemporary urban space - Grey



↔ Stylish hotel room - Smoke



↔ Trendy rooftop bar - Tarmac



THE INSPIRATION >

IMAGE GALLERY >

- ELEGANT PENTHOUSE
- SCENIC OUTDOOR VILLA
- REFINED OPEN SPACE VILLA
- SOPHISTICATED BATHROOM
- EMOTIONAL IN & OUT LIVING
- CONTEMPORARY URBAN SPACE
- STYLISH HOTEL ROOM
- TRENDY ROOFTOP BAR

SURFACE RANGE & TECHNICAL SPECIFICATIONS >

ENJOY THE VIDEO ▶



Elegant penthouse

FLOOR
 Boost Mineral White Elegant
 Matte/Matt Sensitech
 120x240 cm | 47 1/4" x 94 1/2"

WALL
 Boost Mineral White Elegant
 Matte/Matt
 120x278 cm | 47 1/4" x 109 1/2"

Boost Pro Clay
 Matte/Matt
 120x278 cm | 47 1/4" x 109 1/2"

THE INSPIRATION >

IMAGE GALLERY >

- ELEGANT PENTHOUSE
- SCENIC OUTDOOR VILLA
- REFINED OPEN SPACE VILLA
- SOPHISTICATED BATHROOM
- EMOTIONAL IN & OUT LIVING
- CONTEMPORARY URBAN SPACE
- STYLISH HOTEL ROOM
- TRENDY ROOFTOP BAR

SURFACE RANGE & TECHNICAL SPECIFICATIONS >

ENJOY THE VIDEO



FLOOR
Boost Mineral White
Grip Sensitech
60x120 cm | 23⁵/₈" x 47¹/₄"

Boost Mineral White Elegant
Matte/Matt Sensitech
120x240 cm | 47¹/₄" x 94¹/₂"

WALL
Boost Pro Clay
Matte/Matt
120x278 cm | 47¹/₄" x 109¹/₂"

THE INSPIRATION >

IMAGE GALLERY >

- ELEGANT PENTHOUSE
- SCENIC OUTDOOR VILLA
- REFINED OPEN SPACE VILLA
- SOPHISTICATED BATHROOM
- EMOTIONAL IN & OUT LIVING
- CONTEMPORARY URBAN SPACE
- STYLISH HOTEL ROOM
- TRENDY ROOFTOP BAR

SURFACE RANGE & TECHNICAL SPECIFICATIONS >

ENJOY THE VIDEO

Boost Mineral White

INDEX



THE INSPIRATION >

IMAGE GALLERY >

ELEGANT PENTHOUSE

SCENIC OUTDOOR VILLA

REFINED OPEN SPACE VILLA

SOPHISTICATED BATHROOM

EMOTIONAL IN & OUT LIVING

CONTEMPORARY URBAN SPACE

STYLISH HOTEL ROOM

TRENDY ROOFTOP BAR

SURFACE RANGE & TECHNICAL SPECIFICATIONS >

ENJOY THE VIDEO



FLOOR
Boost Mineral White Elegant
 Matte/Matt Sensitech
 120x240 cm | 47¹/₄"x94¹/₂"

Boost Mineral White
 Grip Sensitech
 60x120 cm | 23⁵/₈"x47¹/₄"

WALL
Boost Mineral White Elegant
 Matte/Matt
 120x278 cm | 47¹/₄"x109¹/₂"

Boost Pro Clay
 Matte/Matt
 120x278 cm | 47¹/₄"x109¹/₂"

FURNITURE
 Atlas Plan
Calacatta Borghini
 Matte/Matt
 162x324 cm | 63³/₄"x127¹/₂"



THE INSPIRATION >

IMAGE GALLERY >

- ELEGANT PENTHOUSE
- SCENIC OUTDOOR VILLA
- REFINED OPEN SPACE VILLA
- SOPHISTICATED BATHROOM
- EMOTIONAL IN & OUT LIVING
- CONTEMPORARY URBAN SPACE
- STYLISH HOTEL ROOM
- TRENDY ROOFTOP BAR

SURFACE RANGE & TECHNICAL SPECIFICATIONS >

ENJOY THE VIDEO ▶



FLOOR
Boost Mineral White Elegant
 Matte/Matt Sensitech
 120x240 cm | 47¹/₄"x94¹/₂"

WALL
Boost Mineral White Elegant
 Matte/Matt
 120x278 cm | 47¹/₄"x109¹/₂"

Boost Pro Clay
 Matte/Matt
 120x278 cm | 47¹/₄"x109¹/₂"

COUNTERTOP
 Atlas Plan
Calacatta Borghini
 Matte/Matt
 162x324 cm | 63³/₄"x127¹/₂"

THE INSPIRATION >

IMAGE GALLERY >

- ELEGANT PENTHOUSE
- SCENIC OUTDOOR VILLA
- REFINED OPEN SPACE VILLA
- SOPHISTICATED BATHROOM
- EMOTIONAL IN & OUT LIVING
- CONTEMPORARY URBAN SPACE
- STYLISH HOTEL ROOM
- TRENDY ROOFTOP BAR

SURFACE RANGE & TECHNICAL SPECIFICATIONS >

ENJOY THE VIDEO 



Scenic outdoor villa

WALL
 Boost Mineral White
 Brick
 30x60 cm | 11³/₄" x 23³/₈"

FLOOR
 Boost Mineral White
 Outdoor Sensitech \times 20 mm
 120x120 cm | 47¹/₄" x 47¹/₄"

THE INSPIRATION >

IMAGE GALLERY >

ELEGANT PENTHOUSE

SCENIC OUTDOOR VILLA

REFINED OPEN SPACE VILLA

SOPHISTICATED BATHROOM

EMOTIONAL IN & OUT LIVING

CONTEMPORARY URBAN SPACE

STYLISH HOTEL ROOM

TRENDY ROOFTOP BAR

SURFACE RANGE & TECHNICAL SPECIFICATIONS >

ENJOY THE VIDEO 

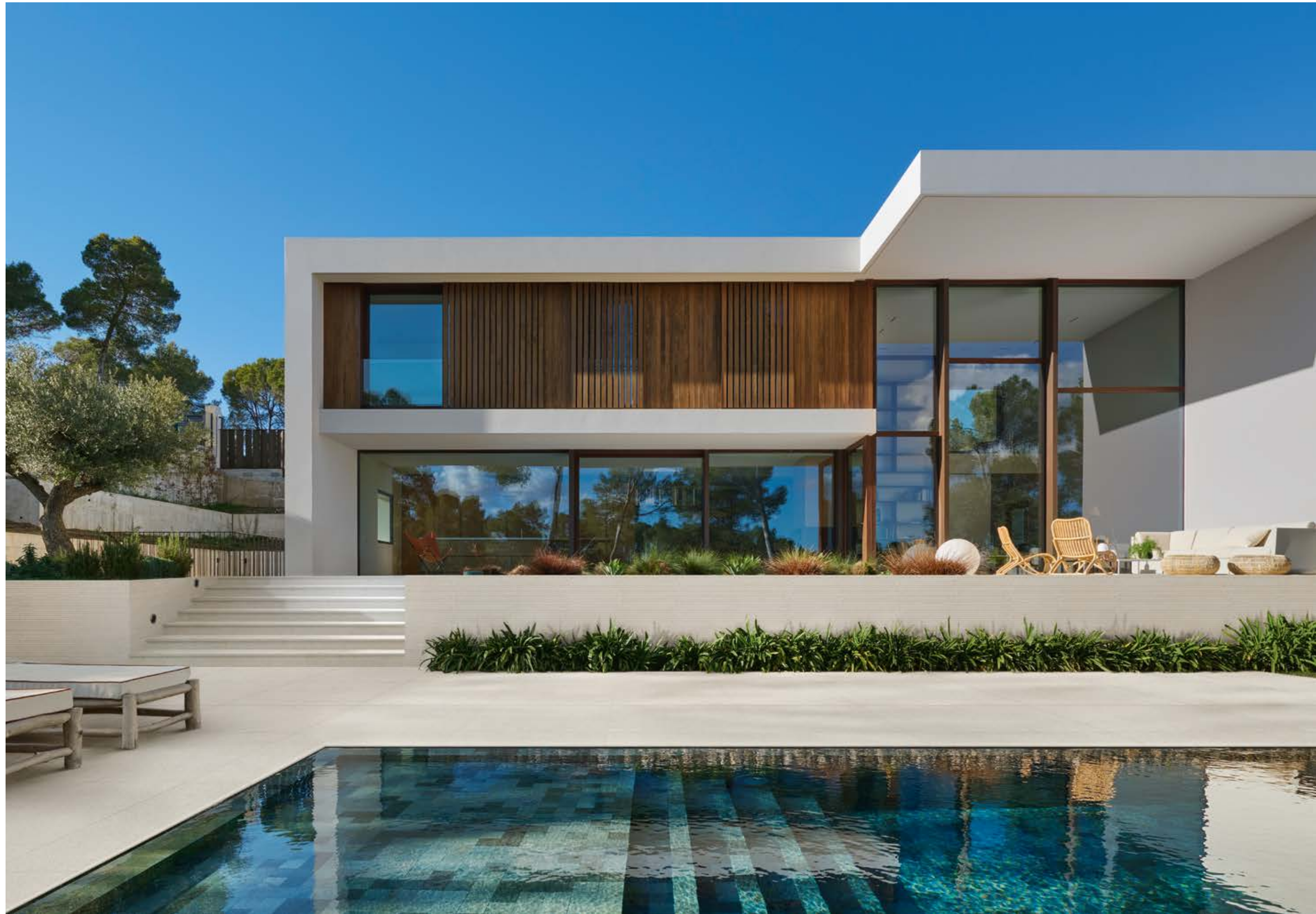

FLOOR
Boost Mineral White
 Outdoor Sensitech 20 mm
 120x120 cm | 47¹/₄"x47¹/₄"

WALL
Boost Mineral White
 Brick
 30x60 cm | 11³/₄"x23⁵/₈"

THE INSPIRATION >

IMAGE GALLERY >

ELEGANT PENTHOUSE

SCENIC OUTDOOR VILLA

REFINED OPEN SPACE VILLA

SOPHISTICATED BATHROOM

EMOTIONAL IN & OUT LIVING

CONTEMPORARY URBAN SPACE

STYLISH HOTEL ROOM

TRENDY ROOFTOP BAR

SURFACE RANGE & TECHNICAL SPECIFICATIONS >

ENJOY THE VIDEO ▶

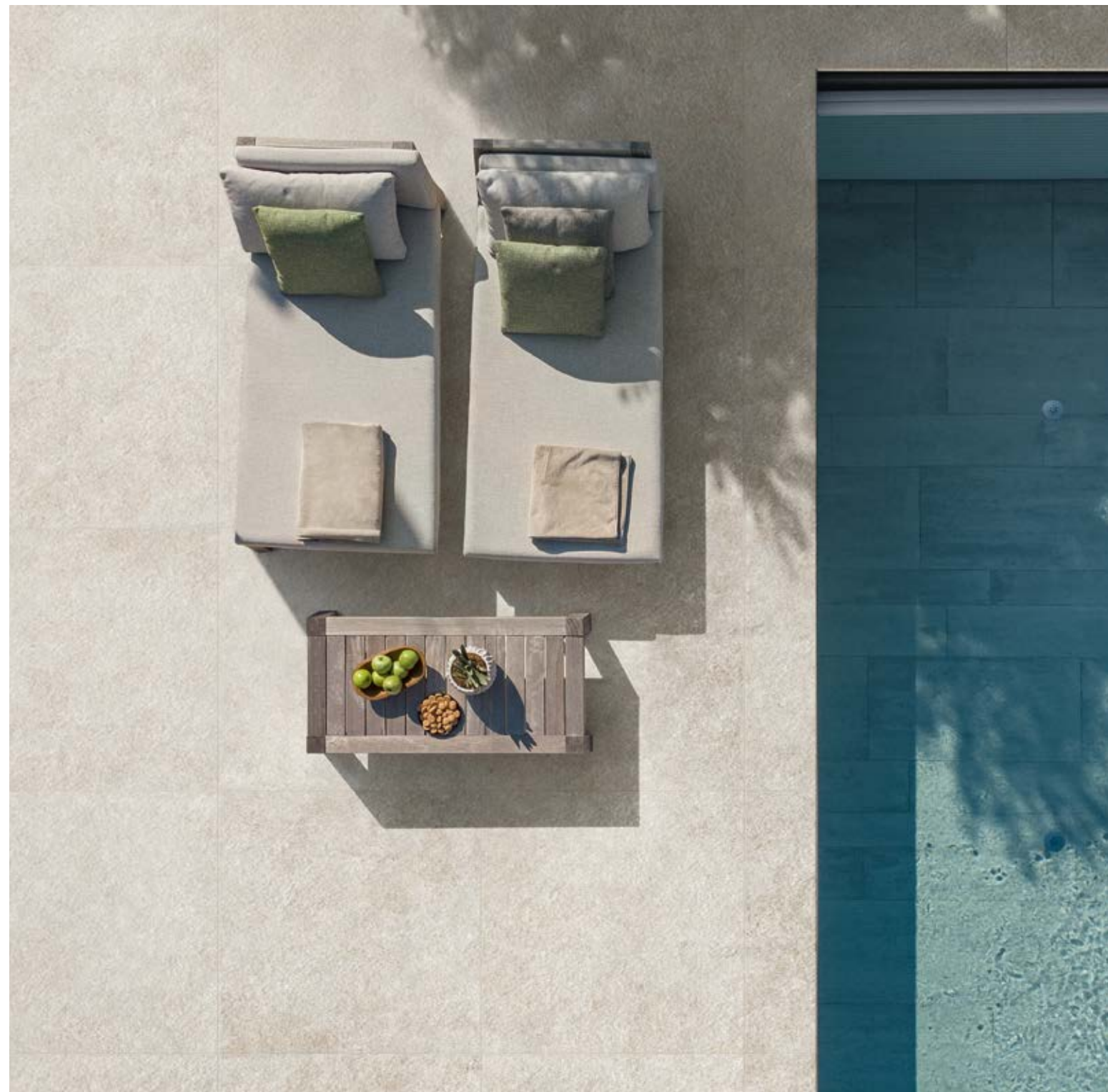

FLOOR
Boost Mineral White
 Outdoor Sensitech 20 mm
 120x120 cm | 47 1/4" x 47 1/4"



THE INSPIRATION >

IMAGE GALLERY >

ELEGANT PENTHOUSE

SCENIC OUTDOOR VILLA

REFINED OPEN SPACE VILLA

SOPHISTICATED BATHROOM

EMOTIONAL IN & OUT LIVING

CONTEMPORARY URBAN SPACE

STYLISH HOTEL ROOM

TRENDY ROOFTOP BAR

SURFACE RANGE & TECHNICAL SPECIFICATIONS >

ENJOY THE VIDEO ▶



FLOOR
Boost Mineral White
 Matte/Matt Sensitech
 120x120 cm | 47¹/₄"x47¹/₄"

Boost Mineral White
 Outdoor Sensitech 20 mm
 120x120 cm | 47¹/₄"x47¹/₄"

Boost Mineral White
 Slice A+B 20 mm
 60x120 cm | 23⁵/₈"x47¹/₄"

THE INSPIRATION >

IMAGE GALLERY >

ELEGANT PENTHOUSE

SCENIC OUTDOOR VILLA

REFINED OPEN SPACE VILLA

SOPHISTICATED BATHROOM

EMOTIONAL IN & OUT LIVING

CONTEMPORARY URBAN SPACE

STYLISH HOTEL ROOM

TRENDY ROOFTOP BAR

SURFACE RANGE & TECHNICAL SPECIFICATIONS >

ENJOY THE VIDEO ▶

Refined open space villa



FLOOR
Boost Mineral Pearl
 Outdoor Sensitech 20 mm
 60x120 cm | 23⁵/₈"x47¹/₂"

Boost Mineral Pearl Elegant
 Matte/Matt Sensitech
 120x240 cm | 47¹/₂"x94¹/₂"

WALL
Boost Mineral Pearl Elegant
 Matte/Matt
 120x278 cm | 47¹/₂"x109¹/₂"

COUNTERTOP
 Atlas Plan
Boost Mineral Grey
 Hammered
 162x324 cm | 63⁵/₈"x127¹/₂"

THE INSPIRATION >

IMAGE GALLERY >

ELEGANT PENTHOUSE
SCENIC OUTDOOR VILLA

REFINED OPEN SPACE VILLA

SOPHISTICATED BATHROOM

EMOTIONAL IN & OUT LIVING

CONTEMPORARY URBAN SPACE

STYLISH HOTEL ROOM

TRENDY ROOFTOP BAR

SURFACE RANGE & TECHNICAL SPECIFICATIONS >

ENJOY THE VIDEO ▶



FLOOR
Boost Mineral Pearl Elegant
 Matte/Matt Sensitech
 120x240 cm | 47¹/₄"x94¹/₂"

Boost Mineral Pearl
 Outdoor Sensitech 20 mm
 60x120 cm | 23⁵/₈"x47¹/₄"

WALL
Boost Mineral Pearl Elegant
 Matte/Matt
 120x278 cm | 47¹/₄"x109¹/₂"

Boost White
 Matte/Matt
 120x278 cm | 47¹/₄"x109¹/₂"

COUNTERTOP
 Atlas Plan
Boost Mineral Grey
 Hammered
 162x324 cm | 63³/₄"x127¹/₂"

THE INSPIRATION >

IMAGE GALLERY >

ELEGANT PENTHOUSE
SCENIC OUTDOOR VILLA

REFINED OPEN SPACE VILLA

SOPHISTICATED BATHROOM

EMOTIONAL IN & OUT LIVING

CONTEMPORARY URBAN SPACE

STYLISH HOTEL ROOM

TRENDY ROOFTOP BAR

SURFACE RANGE & TECHNICAL SPECIFICATIONS >

ENJOY THE VIDEO ▶

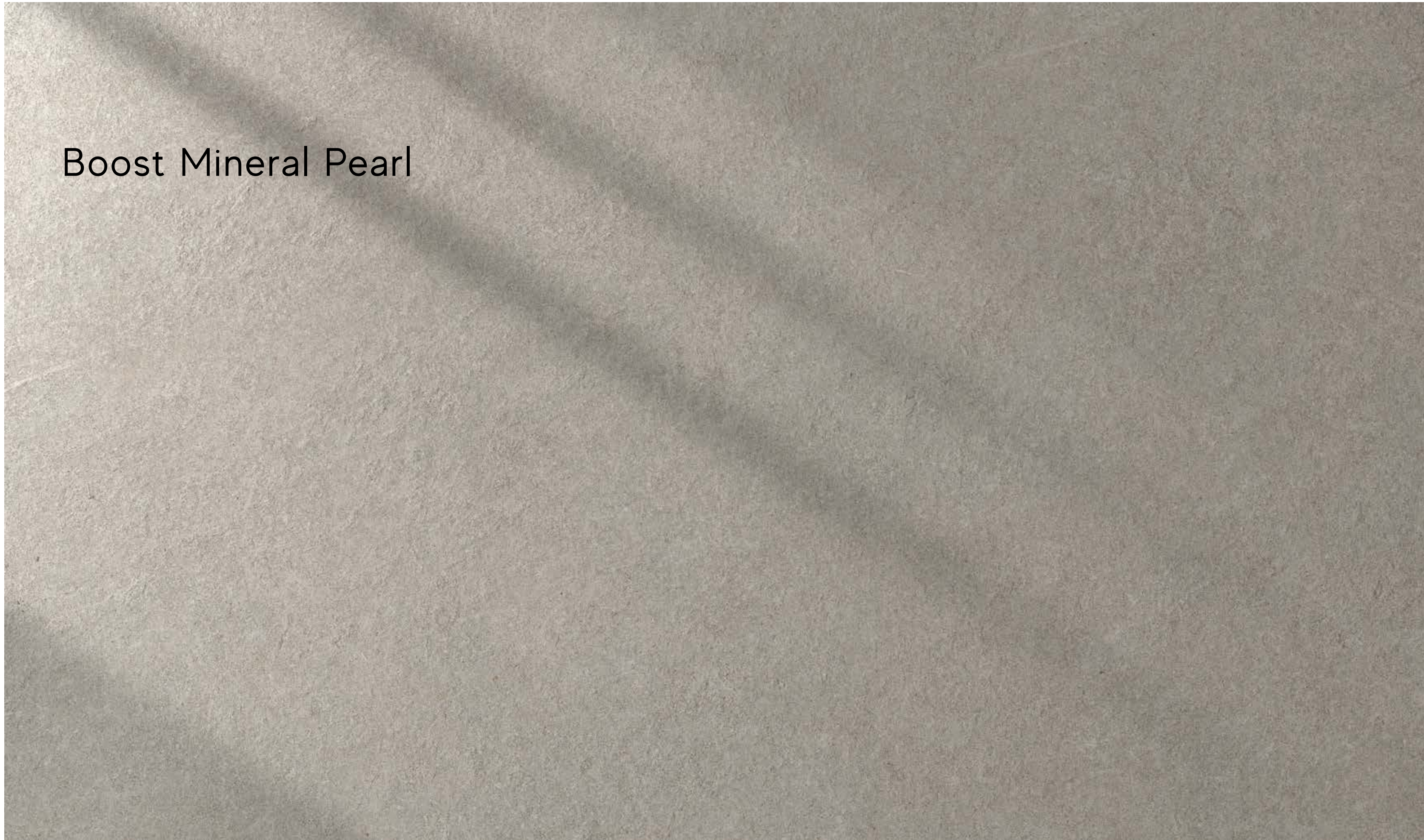

Boost Mineral Pearl

THE INSPIRATION >

IMAGE GALLERY >

ELEGANT PENTHOUSE
SCENIC OUTDOOR VILLA

REFINED OPEN SPACE VILLA

SOPHISTICATED BATHROOM
EMOTIONAL IN & OUT LIVING
CONTEMPORARY URBAN SPACE
STYLISH HOTEL ROOM
TRENDY ROOFTOP BAR

SURFACE RANGE & TECHNICAL SPECIFICATIONS >

ENJOY THE VIDEO

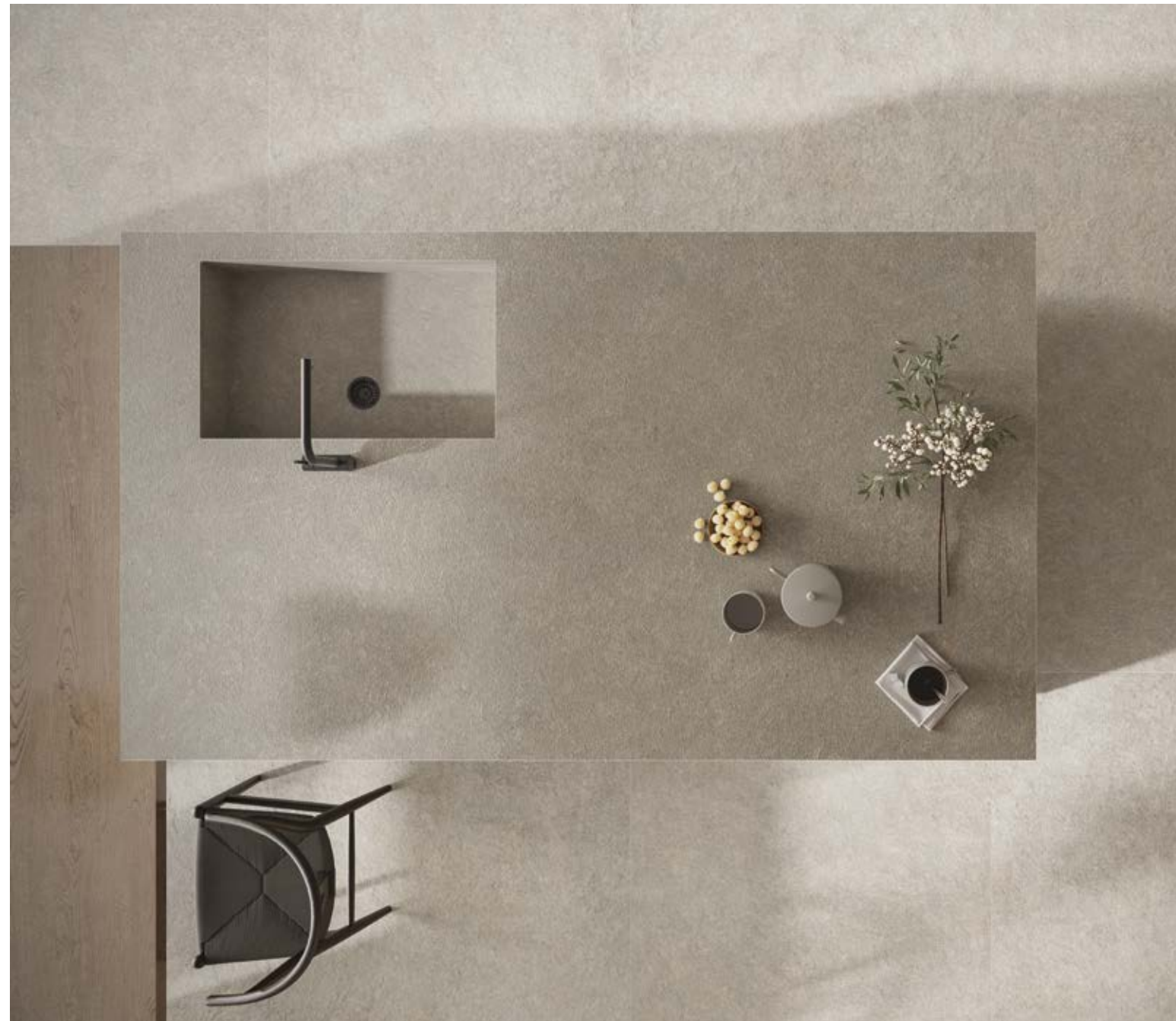

FLOOR
Boost Mineral Pearl Elegant
 Matte/Matt Sensitech
 120x240 cm | 47¹/₄"x94¹/₂"

WALL
Boost Mineral Pearl Elegant
 Matte/Matt
 120x278 cm | 47¹/₄"x109¹/₂"

Boost White
 Matte/Matt
 120x278 cm | 47¹/₄"x109¹/₂"

COUNTERTOP
 Atlas Plan
Boost Mineral Grey
 Hammered
 162x324 cm | 63³/₄"x127¹/₂"



THE INSPIRATION >

IMAGE GALLERY >

ELEGANT PENTHOUSE
SCENIC OUTDOOR VILLA

REFINED OPEN SPACE VILLA

SOPHISTICATED BATHROOM

EMOTIONAL IN & OUT LIVING

CONTEMPORARY URBAN SPACE

STYLISH HOTEL ROOM

TRENDY ROOFTOP BAR

SURFACE RANGE & TECHNICAL SPECIFICATIONS >

ENJOY THE VIDEO ▶



FLOOR
Boost Mineral Pearl Elegant
 Matte/Matt Sensitech
 120x240 cm | 47¹/₄"x94¹/₂"

Boost Mineral Pearl
 Outdoor Sensitech 20mm
 60x120 cm | 23³/₈"x47¹/₄"



THE INSPIRATION >

IMAGE GALLERY >

ELEGANT PENTHOUSE
SCENIC OUTDOOR VILLA

REFINED OPEN SPACE VILLA

SOPHISTICATED BATHROOM

EMOTIONAL IN & OUT LIVING

CONTEMPORARY URBAN SPACE

STYLISH HOTEL ROOM

TRENDY ROOFTOP BAR

SURFACE RANGE & TECHNICAL SPECIFICATIONS >

ENJOY THE VIDEO ▶

Sophisticated bathroom



FLOOR
Boost Mineral Pearl
 Matte/Matt Sensitech
 75x150 cm | 29 1/2" x 59"

Exence Almond
 Tatami
 18,5x75 cm | 7 1/4" x 29 1/2"

WALL
Boost Mineral Pearl
 Matte/Matt Sensitech
 75x150 cm | 29 1/2" x 59"

SINK
 Atlas Concorde Habitat
 Mastertop
Boost Mineral Pearl Elegant
 Matte/Matt
 180x50x12 cm | 70 7/8" x 19 3/8" x 4 1/2"

THE INSPIRATION >

IMAGE GALLERY >

- ELEGANT PENTHOUSE
- SCENIC OUTDOOR VILLA
- REFINED OPEN SPACE VILLA
- SOPHISTICATED BATHROOM
- EMOTIONAL IN & OUT LIVING
- CONTEMPORARY URBAN SPACE
- STYLISH HOTEL ROOM
- TRENDY ROOFTOP BAR

SURFACE RANGE & TECHNICAL SPECIFICATIONS >

ENJOY THE VIDEO ▶



FLOOR

Boost Mineral Pearl
Matte/Matt Sensitech
75x150 cm | 29 1/2"x59"

Exence Almond

Tatami
18,5x75 cm | 7 1/4"x29 1/2"

WALL

Boost Mineral Pearl
Matte/Matt Sensitech
75x150 cm | 29 1/2"x59"

SINK

Atlas Concorde Habitat
Mastertop

Boost Mineral Pearl Elegant
Matte/Matt
180x50x12 cm | 70 7/8"x19 5/8"x4 3/4"

THE INSPIRATION >

IMAGE GALLERY >

ELEGANT PENTHOUSE
SCENIC OUTDOOR VILLA
REFINED OPEN SPACE VILLA

SOPHISTICATED BATHROOM

EMOTIONAL IN & OUT LIVING
CONTEMPORARY URBAN SPACE
STYLISH HOTEL ROOM
TRENDY ROOFTOP BAR

SURFACE RANGE & TECHNICAL SPECIFICATIONS >

ENJOY THE VIDEO ▶



FLOOR
Boost Mineral Pearl
 Matte/Matt Sensitech
 75x150 cm | 29 1/2" x 59"

WALL
Boost Mineral Pearl
 Matte/Matt Sensitech
 75x150 cm | 29 1/2" x 59"

Exence Almond
 Tatami
 18,5x75 cm | 7 1/4" x 29 1/2"

THE INSPIRATION >

IMAGE GALLERY >

ELEGANT PENTHOUSE
 SCENIC OUTDOOR VILLA
 REFINED OPEN SPACE VILLA

SOPHISTICATED BATHROOM
 EMOTIONAL IN & OUT LIVING
 CONTEMPORARY URBAN SPACE
 STYLISH HOTEL ROOM
 TRENDY ROOFTOP BAR

SURFACE RANGE & TECHNICAL SPECIFICATIONS >

ENJOY THE VIDEO ▶

FLOOR

Boost Mineral Pearl
Matte/Matt Sensitech
75x150 cm | 29 1/2"x59"

Exence Almond

Tatami
18,5x75 cm | 7 1/4"x29 1/2"

WALL

Boost Mineral Pearl
Matte/Matt Sensitech
75x150 cm | 29 1/2"x59"

SINK

Atlas Concorde Habitat
Mastertop

Boost Mineral Pearl Elegant

Matte/Matt
180x50x12 cm | 70 7/8"x19 5/8"x4 3/4"

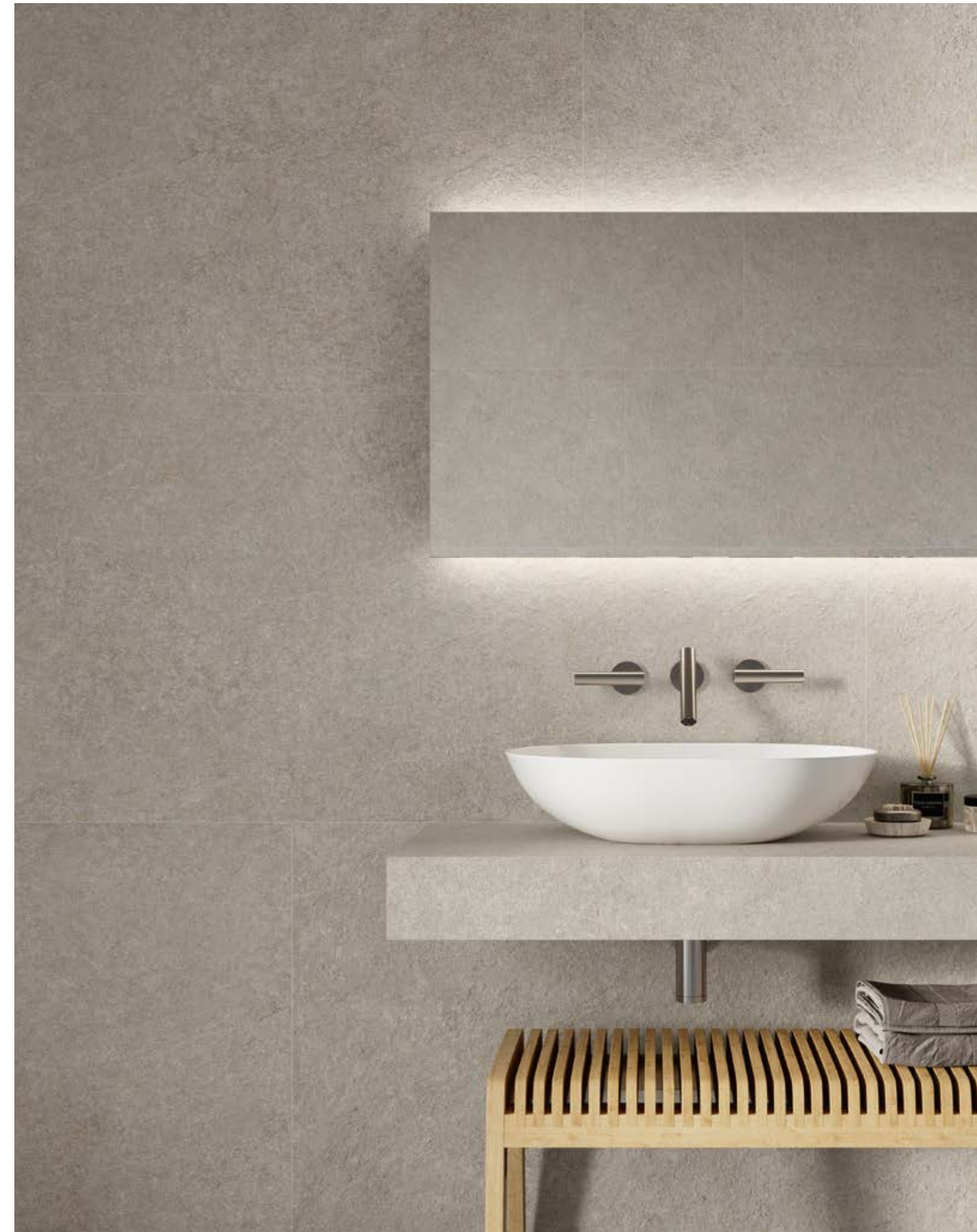

THE INSPIRATION >

IMAGE GALLERY >

- ELEGANT PENTHOUSE
- SCENIC OUTDOOR VILLA
- REFINED OPEN SPACE VILLA
- SOPHISTICATED BATHROOM
- EMOTIONAL IN & OUT LIVING
- CONTEMPORARY URBAN SPACE
- STYLISH HOTEL ROOM
- TRENDY ROOFTOP BAR

SURFACE RANGE & TECHNICAL SPECIFICATIONS >

ENJOY THE VIDEO ▶

Emotional in & out living



FLOOR
 Boost Mineral Grey
 Outdoor Sensitech 20 mm
 120x120 cm | 47 1/8" x 47 1/8"

WALL
 Boost Mineral Grey
 Brick
 30x60 cm | 11 1/8" x 23 5/8"

WALL
 Boost White
 Matte/Matt
 120x278 cm | 47 1/8" x 109 1/2"

THE INSPIRATION >

IMAGE GALLERY >

- ELEGANT PENTHOUSE
- SCENIC OUTDOOR VILLA
- REFINED OPEN SPACE VILLA
- SOPHISTICATED BATHROOM

- EMOTIONAL IN & OUT LIVING
- CONTEMPORARY URBAN SPACE
- STYLISH HOTEL ROOM
- TRENDY ROOFTOP BAR

SURFACE RANGE & TECHNICAL SPECIFICATIONS >

ENJOY THE VIDEO ▶



FLOOR
Boost Mineral Grey
 Matte/Matt Sensitech
 120x120 cm | 47¹/₄"x47¹/₄"

Boost Mineral Grey
 Outdoor Sensitech \pm 20 mm
 120x120 cm | 47¹/₄"x47¹/₄"

WALL
Boost Mineral Grey
 Matte/Matt Sensitech
 60x120 cm | 23⁵/₈"x47¹/₄"

Boost Tarmac
 Matte/Matt
 120x278 cm | 47¹/₄"x109¹/₂"

Boost Mineral Grey
 Brick
 30x60 cm | 11³/₄"x23⁵/₈"

THE INSPIRATION >

IMAGE GALLERY >

ELEGANT PENTHOUSE
 SCENIC OUTDOOR VILLA
 REFINED OPEN SPACE VILLA
 SOPHISTICATED BATHROOM

EMOTIONAL IN & OUT LIVING

CONTEMPORARY URBAN SPACE
 STYLISH HOTEL ROOM
 TRENDY ROOFTOP BAR

SURFACE RANGE & TECHNICAL SPECIFICATIONS >

ENJOY THE VIDEO ▶

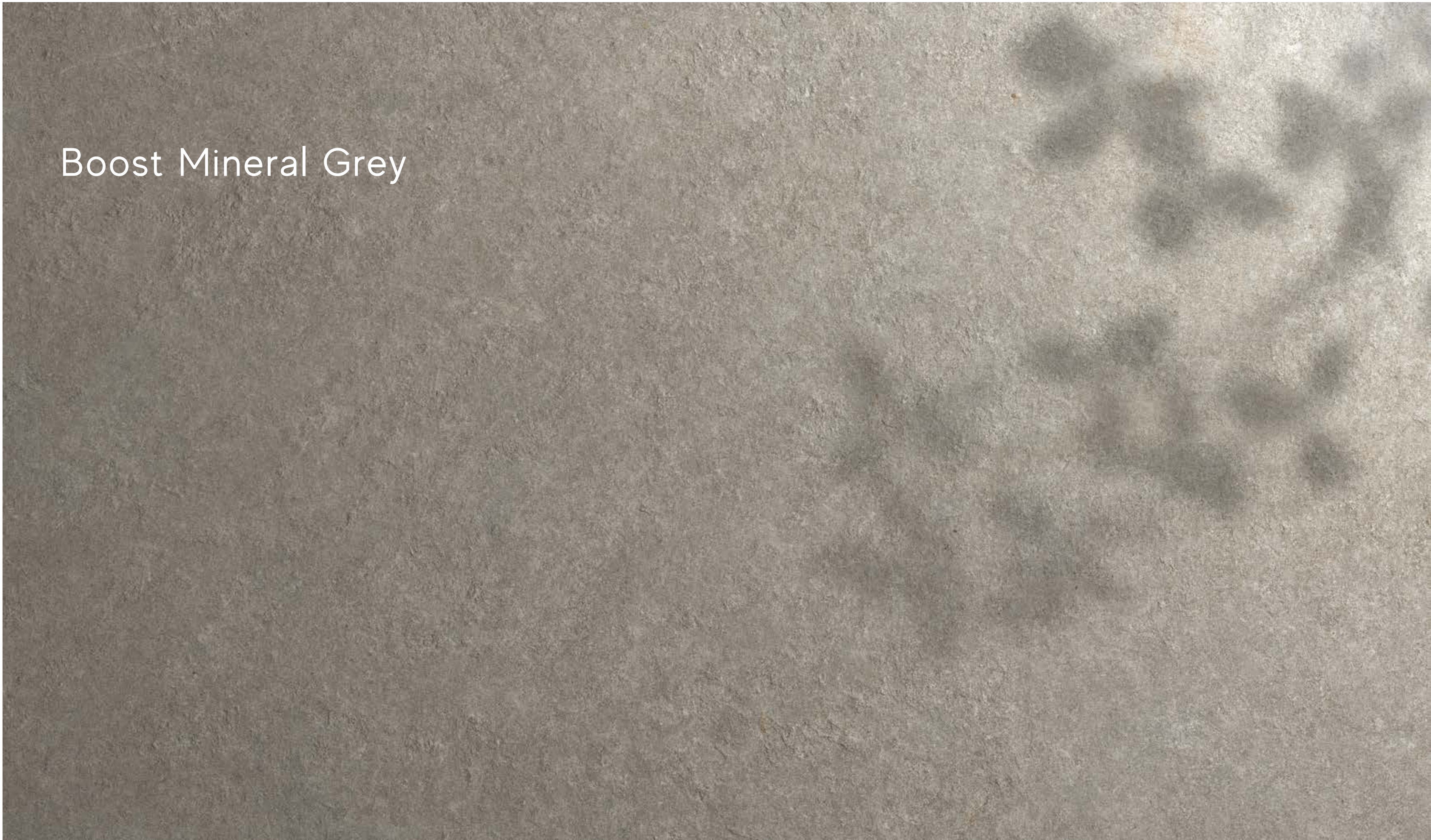

Boost Mineral Grey

THE INSPIRATION >

IMAGE GALLERY >

- ELEGANT PENTHOUSE
- SCENIC OUTDOOR VILLA
- REFINED OPEN SPACE VILLA
- SOPHISTICATED BATHROOM

EMOTIONAL IN & OUT LIVING

- CONTEMPORARY URBAN SPACE
- STYLISH HOTEL ROOM
- TRENDY ROOFTOP BAR

SURFACE RANGE & TECHNICAL SPECIFICATIONS >

ENJOY THE VIDEO



FLOOR
Boost Mineral Grey
 Outdoor Sensitech ✕ 20 mm
 120x120 cm | 47¹/₄"x47¹/₄"

WALL
Boost Mineral Grey
 Brick
 30x60 cm | 11³/₄"x23⁵/₈"

THE INSPIRATION >

IMAGE GALLERY >

- ELEGANT PENTHOUSE
- SCENIC OUTDOOR VILLA
- REFINED OPEN SPACE VILLA
- SOPHISTICATED BATHROOM

- EMOTIONAL IN & OUT LIVING
- CONTEMPORARY URBAN SPACE
- STYLISH HOTEL ROOM
- TRENDY ROOFTOP BAR

SURFACE RANGE & TECHNICAL SPECIFICATIONS >

ENJOY THE VIDEO 



FLOOR
Boost Mineral Grey
 Outdoor Sensitech 20 mm
 120x120 cm | 47 1/4" x 47 1/4"

WALL
Boost White
 Matte/Matt
 120x278 cm | 47 1/4" x 109 1/2"

Boost Mineral Grey
 Matte/Matt Sensitech
 120x120 cm | 47 1/4" x 47 1/4"



THE INSPIRATION >

IMAGE GALLERY >

- ELEGANT PENTHOUSE
- SCENIC OUTDOOR VILLA
- REFINED OPEN SPACE VILLA
- SOPHISTICATED BATHROOM

EMOTIONAL IN & OUT LIVING

- CONTEMPORARY URBAN SPACE
- STYLISH HOTEL ROOM
- TRENDY ROOFTOP BAR

SURFACE RANGE & TECHNICAL SPECIFICATIONS >

ENJOY THE VIDEO ▶



FLOOR
Boost Mineral Grey
 Matte/Matt Sensitech
 120x120 cm | 47¹/₄"x47¹/₄"

WALL
Boost Mineral Grey
 Matte/Matt Sensitech
 60x120 cm | 23⁵/₈"x47¹/₄"

Boost Tarmac
 Matte/Matt
 120x278 cm | 47¹/₄"x94¹/₂"



THE INSPIRATION >

IMAGE GALLERY >

- ELEGANT PENTHOUSE
- SCENIC OUTDOOR VILLA
- REFINED OPEN SPACE VILLA
- SOPHISTICATED BATHROOM

EMOTIONAL IN & OUT LIVING

- CONTEMPORARY URBAN SPACE
- STYLISH HOTEL ROOM
- TRENDY ROOFTOP BAR

SURFACE RANGE & TECHNICAL SPECIFICATIONS >

ENJOY THE VIDEO ▶



FLOOR
Boost Mineral Grey
 Matte/Matt Sensitech
 120x120 cm | 47¹/₄"x47¹/₄"

Boost Mineral Grey
 Outdoor Sensitech ∇ 20 mm
 120x120 cm | 47¹/₄"x47¹/₄"

WALL
Boost Mineral Grey
 Matte/Matt Sensitech
 60x120 cm | 23⁵/₈"x47¹/₄"

Boost Tarmac
 Matte/Matt
 120x278 cm | 47¹/₄"x94¹/₂"

THE INSPIRATION >

IMAGE GALLERY >

- ELEGANT PENTHOUSE
- SCENIC OUTDOOR VILLA
- REFINED OPEN SPACE VILLA
- SOPHISTICATED BATHROOM

EMOTIONAL IN & OUT LIVING

- CONTEMPORARY URBAN SPACE
- STYLISH HOTEL ROOM
- TRENDY ROOFTOP BAR

SURFACE RANGE & TECHNICAL SPECIFICATIONS >

ENJOY THE VIDEO ▶



WALL
Boost Mineral Grey
 Venus Lux
 60x120 cm - 23⁵/₈"x47¹/₄"

FLOOR
Boost Mineral Grey
 Matte/Matt Sensitech
 120x120 cm | 47¹/₄"x47¹/₄"

THE INSPIRATION >

IMAGE GALLERY >

- ELEGANT PENTHOUSE
- SCENIC OUTDOOR VILLA
- REFINED OPEN SPACE VILLA
- SOPHISTICATED BATHROOM

EMOTIONAL IN & OUT LIVING

- CONTEMPORARY URBAN SPACE
- STYLISH HOTEL ROOM
- TRENDY ROOFTOP BAR

SURFACE RANGE & TECHNICAL SPECIFICATIONS >

ENJOY THE VIDEO ▶



Contemporary urban space

FLOOR
Boost Mineral Grey Elegant
 Outdoor Sensitech ✦ 20 mm
 120x240 cm | 47 1/4" x 94 1/2"

WALL
Boost Mineral Grey Elegant
 Matte/Matt Sensitech
 120x240 cm | 47 1/4" x 94 1/2"

FURNITURE
 Atlas Plan
Boost Mineral Grey
 Hammered
 162x324 cm | 63 3/4" x 127 1/2"

THE INSPIRATION >

IMAGE GALLERY >

- ELEGANT PENTHOUSE
- SCENIC OUTDOOR VILLA
- REFINED OPEN SPACE VILLA
- SOPHISTICATED BATHROOM
- EMOTIONAL IN & OUT LIVING
- CONTEMPORARY URBAN SPACE
- STYLISH HOTEL ROOM
- TRENDY ROOFTOP BAR

SURFACE RANGE & TECHNICAL SPECIFICATIONS >

ENJOY THE VIDEO



FLOOR
Boost Mineral Grey Elegant
 Outdoor Sensitech ✕ 20 mm
 120x240 cm | 47¹/₄"x94¹/₂"

WALL
Boost Mineral Grey Elegant
 Matte/Matt Sensitech
 120x240 cm | 47¹/₄"x94¹/₂"

FURNITURE
 Atlas Plan
Boost Mineral Grey
 Hammered
 162x324 cm | 63³/₄"x127¹/₂"



THE INSPIRATION >

IMAGE GALLERY >

- ELEGANT PENTHOUSE
- SCENIC OUTDOOR VILLA
- REFINED OPEN SPACE VILLA
- SOPHISTICATED BATHROOM
- EMOTIONAL IN & OUT LIVING
- CONTEMPORARY URBAN SPACE
- STYLISH HOTEL ROOM
- TRENDY ROOFTOP BAR

SURFACE RANGE & TECHNICAL SPECIFICATIONS >

ENJOY THE VIDEO 



Stylish hotel room

FLOOR
Boost Mineral Smoke
 Matte/Matt Sensitech
 120x120 cm | 47 1/4" x 47 1/4"

Entice Copper Oak Natural
 Matte/Matt Sensitech
 18,5x150 cm | 7 1/4" x 59"

WALL
Boost Mineral Smoke Elegant
 Matte/Matt
 120x278 cm | 47 1/4" x 109 1/2"

SINK & SHELF
 Atlas Concorde Habitat
 Twin wall-mounted sink
Boost Tarmac
 Matte/Matt
 210x50x15 cm | 82 2/8" x 19 3/8" x 5 7/8"

Shelf
Boost Tarmac
 Matte/Matt
 210x35x5 cm | 82 2/8" x 13 3/4" x 2"

THE INSPIRATION >

IMAGE GALLERY >

- ELEGANT PENTHOUSE
- SCENIC OUTDOOR VILLA
- REFINED OPEN SPACE VILLA
- SOPHISTICATED BATHROOM
- EMOTIONAL IN & OUT LIVING
- CONTEMPORARY URBAN SPACE
- STYLISH HOTEL ROOM
- TRENDY ROOFTOP BAR

SURFACE RANGE & TECHNICAL SPECIFICATIONS >

ENJOY THE VIDEO ▶



FLOOR
Boost Mineral Smoke
 Matte/Matt Sensitech
 120x120 cm | 47¹/₄"x47¹/₄"

Entice Copper Oak Natural
 Matte/Matt Sensitech
 18,5x150 cm | 7¹/₄"x59"

WALL
Boost Mineral Smoke Elegant
 Matte/Matt
 120x278 cm | 47¹/₄"x109¹/₂"

THE INSPIRATION >

IMAGE GALLERY >

- ELEGANT PENTHOUSE
- SCENIC OUTDOOR VILLA
- REFINED OPEN SPACE VILLA
- SOPHISTICATED BATHROOM
- EMOTIONAL IN & OUT LIVING
- CONTEMPORARY URBAN SPACE
- STYLISH HOTEL ROOM
- TRENDY ROOFTOP BAR

SURFACE RANGE & TECHNICAL SPECIFICATIONS >

ENJOY THE VIDEO 



Boost Mineral Smoke

THE INSPIRATION >

IMAGE GALLERY >

- ELEGANT PENTHOUSE
- SCENIC OUTDOOR VILLA
- REFINED OPEN SPACE VILLA
- SOPHISTICATED BATHROOM
- EMOTIONAL IN & OUT LIVING
- CONTEMPORARY URBAN SPACE
- STYLISH HOTEL ROOM
- TRENDY ROOFTOP BAR

SURFACE RANGE & TECHNICAL SPECIFICATIONS >

ENJOY THE VIDEO

FLOOR

Boost Mineral Smoke
Matte/Matt Sensitech
120x120 cm | 47¹/₄"x47¹/₄"

Entice Copper Oak Natural

Matte/Matt Sensitech
18,5x150 cm | 7¹/₄"x59"

WALL

Boost Mineral Smoke Elegant
Matte/Matt
120x278 cm | 47¹/₄"x109¹/₂"

SINK & SHELF

Atlas Concorde Habitat
Twin wall-mounted sink
Boost Tarmac
Matte/Matt
210x50x15 cm | 82⁵/₈"x19⁵/₈"x5⁷/₈"

Shelf

Boost Tarmac
Matte/Matt
210x35x5 cm | 82⁵/₈"x13³/₄"x2"

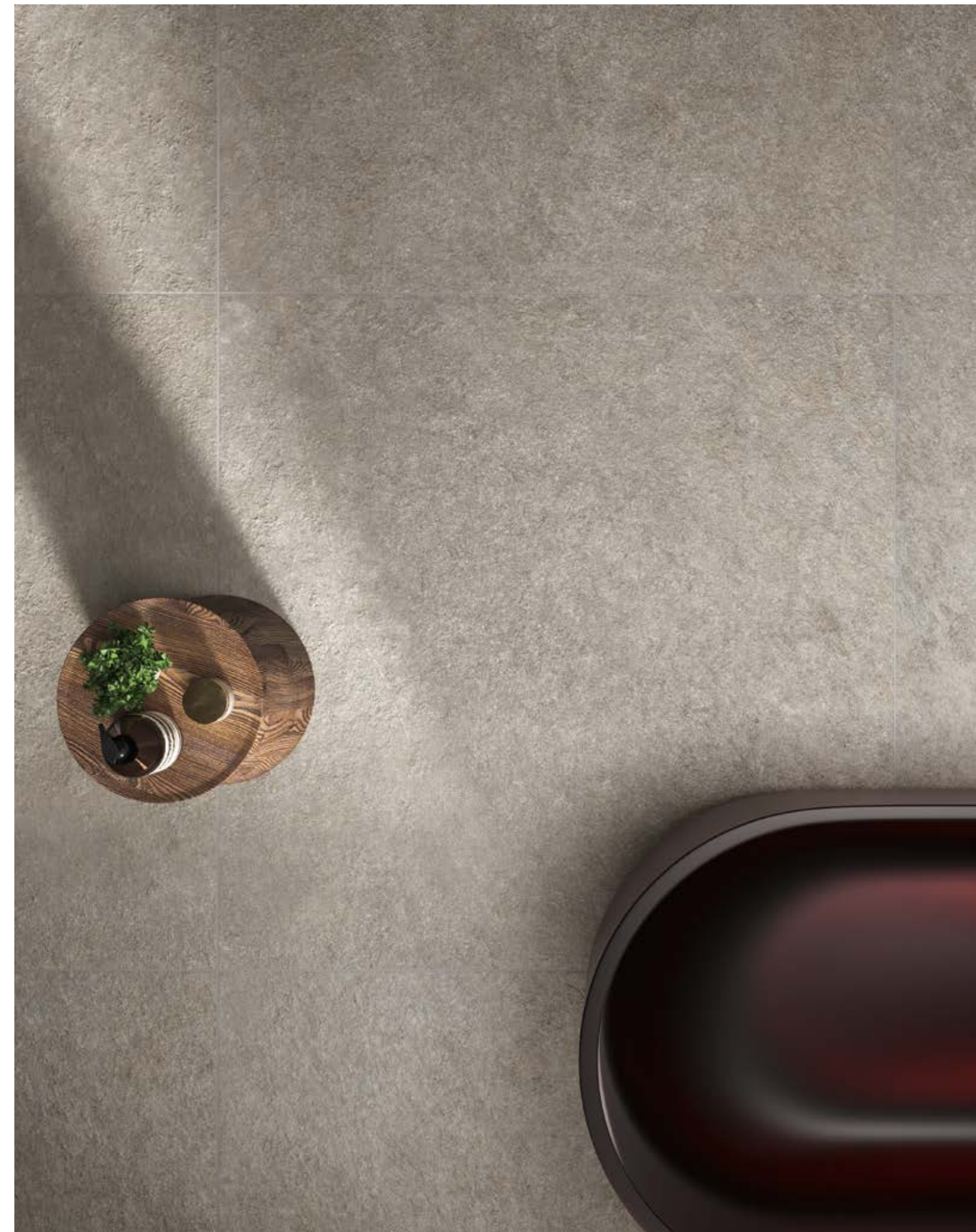

THE INSPIRATION >

IMAGE GALLERY >

- ELEGANT PENTHOUSE
- SCENIC OUTDOOR VILLA
- REFINED OPEN SPACE VILLA
- SOPHISTICATED BATHROOM
- EMOTIONAL IN & OUT LIVING
- CONTEMPORARY URBAN SPACE
- STYLISH HOTEL ROOM
- TRENDY ROOFTOP BAR

SURFACE RANGE & TECHNICAL SPECIFICATIONS >

ENJOY THE VIDEO ▶



FLOOR
Boost Mineral Smoke
 Matte/Matt Sensitech
 120x120 cm | 47¹/₄"x47¹/₄"

Entice Copper Oak Natural
 Matte/Matt Sensitech
 18,5x150 cm | 7¹/₄"x59"

WALL
Boost Mineral Smoke Elegant
 Matte/Matt
 120x278 cm | 47¹/₄"x109¹/₂"

SINK & SHELF
 Atlas Concorde Habitat
 Twin wall-mounted sink
Boost Tarmac
 Matte/Matt
 210x50x15 cm | 82⁵/₈"x19⁹/₈"x5⁷/₈"

Shelf
Boost Tarmac
 Matte/Matt
 210x35x5 cm | 82⁵/₈"x13³/₄"x2"

THE INSPIRATION >

IMAGE GALLERY >

- ELEGANT PENTHOUSE
- SCENIC OUTDOOR VILLA
- REFINED OPEN SPACE VILLA
- SOPHISTICATED BATHROOM
- EMOTIONAL IN & OUT LIVING
- CONTEMPORARY URBAN SPACE
- STYLISH HOTEL ROOM
- TRENDY ROOFTOP BAR

SURFACE RANGE & TECHNICAL SPECIFICATIONS >

ENJOY THE VIDEO ▶

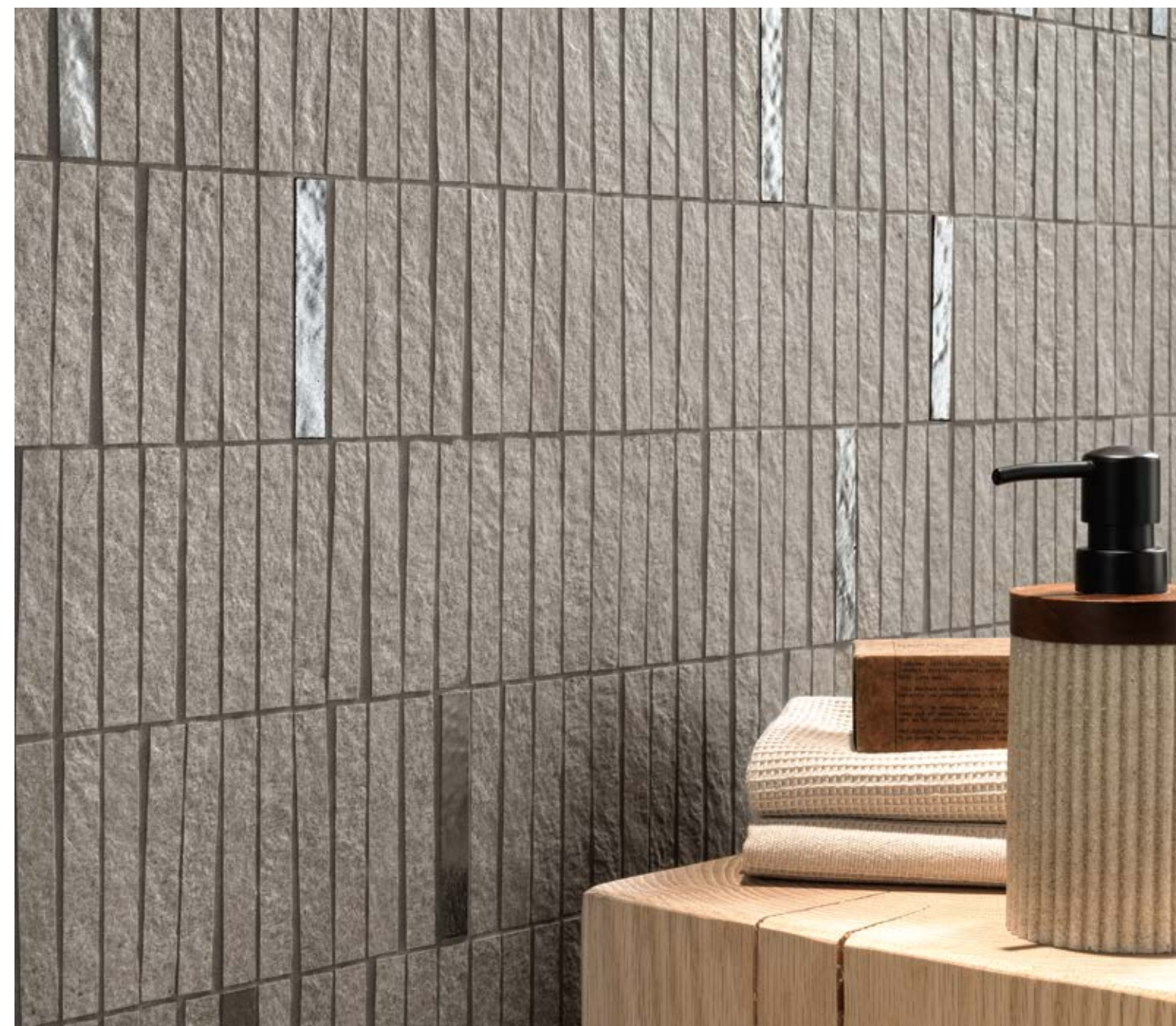

WALL
Boost Mineral Grey
 Domino Lux
 35x29,2 cm - 13³/₄"x11¹/₂"

THE INSPIRATION >

IMAGE GALLERY >

- ELEGANT PENTHOUSE
- SCENIC OUTDOOR VILLA
- REFINED OPEN SPACE VILLA
- SOPHISTICATED BATHROOM
- EMOTIONAL IN & OUT LIVING
- CONTEMPORARY URBAN SPACE
- STYLISH HOTEL ROOM
- TRENDY ROOFTOP BAR

SURFACE RANGE & TECHNICAL SPECIFICATIONS >

ENJOY THE VIDEO 

Trendy rooftop bar



FLOOR
Boost Mineral Tarmac
 Outdoor Sensitech 20 mm
 120x120 cm | 47 1/4" x 94 1/2"

Boost Mineral Tarmac Elegant
 Matte/Matt Sensitech
 120x240 cm | 47 1/4" x 94 1/2"

WALL
Boost Mineral Tarmac Elegant
 Matte/Matt
 120x278 cm | 47 1/4" x 109 1/2"

COUNTERTOP
 Atlas Plan
Boost Mineral Grey
 Hammered
 162x324 cm | 63 3/4" x 127 1/2"

FURNITURE
 Atlas Plan
Boost Mineral Grey
 Hammered
 162x324 cm | 63 3/4" x 127 1/2"

THE INSPIRATION >

IMAGE GALLERY >

- ELEGANT PENTHOUSE
- SCENIC OUTDOOR VILLA
- REFINED OPEN SPACE VILLA
- SOPHISTICATED BATHROOM
- EMOTIONAL IN & OUT LIVING
- CONTEMPORARY URBAN SPACE
- STYLISH HOTEL ROOM
- TRENDY ROOFTOP BAR

SURFACE RANGE & TECHNICAL SPECIFICATIONS >

ENJOY THE VIDEO ▶



FLOOR
Boost Mineral Tarmac Elegant
 Matte/Matt Sensitech
 120x240 cm | 47¹/₄"x94¹/₂"

Boost Mineral Tarmac
 Outdoor Sensitech ✕ 20 mm
 120x120 cm | 47¹/₄"x94¹/₂"

WALL
Boost Mineral Tarmac Elegant
 Matte/Matt
 120x278 cm | 47¹/₄"x109¹/₂"

COUNTERTOP
 Atlas Plan
Boost Mineral Grey
 Hammered
 162x324 cm | 63³/₄"x127¹/₂"

THE INSPIRATION >

IMAGE GALLERY >

- ELEGANT PENTHOUSE
- SCENIC OUTDOOR VILLA
- REFINED OPEN SPACE VILLA
- SOPHISTICATED BATHROOM
- EMOTIONAL IN & OUT LIVING
- CONTEMPORARY URBAN SPACE
- STYLISH HOTEL ROOM
- TRENDY ROOFTOP BAR

SURFACE RANGE & TECHNICAL SPECIFICATIONS >

ENJOY THE VIDEO ▶

Boost Mineral Tarmac

THE INSPIRATION >

IMAGE GALLERY >

- ELEGANT PENTHOUSE
- SCENIC OUTDOOR VILLA
- REFINED OPEN SPACE VILLA
- SOPHISTICATED BATHROOM
- EMOTIONAL IN & OUT LIVING
- CONTEMPORARY URBAN SPACE
- STYLISH HOTEL ROOM
- TRENDY ROOFTOP BAR

SURFACE RANGE & TECHNICAL SPECIFICATIONS >

ENJOY THE VIDEO



FLOOR
Boost Mineral Tarmac Elegant
 Matte/Matt Sensitech
 120x240 cm | 47¹/₄"x94¹/₂"

WALL
Boost Mineral Tarmac Elegant
 Matte/Matt
 120x278 cm | 47¹/₄"x109¹/₂"

COUNTERTOP
 Atlas Plan
Boost Mineral Grey
 Hammered
 162x324 cm | 63³/₄"x127¹/₂"

THE INSPIRATION >

IMAGE GALLERY >

- ELEGANT PENTHOUSE
- SCENIC OUTDOOR VILLA
- REFINED OPEN SPACE VILLA
- SOPHISTICATED BATHROOM
- EMOTIONAL IN & OUT LIVING
- CONTEMPORARY URBAN SPACE
- STYLISH HOTEL ROOM
- TRENDY ROOFTOP BAR

SURFACE RANGE & TECHNICAL SPECIFICATIONS >

ENJOY THE VIDEO ▶



FLOOR
Boost Mineral Tarmac
 Outdoor Sensitech 20 mm
 120x120 cm | 47 1/4" x 94 1/2"

FURNITURE
 Atlas Plan
Boost Mineral Grey
 Hammered
 162x324 cm | 63 3/4" x 127 1/2"



THE INSPIRATION >

IMAGE GALLERY >

- ELEGANT PENTHOUSE
- SCENIC OUTDOOR VILLA
- REFINED OPEN SPACE VILLA
- SOPHISTICATED BATHROOM
- EMOTIONAL IN & OUT LIVING
- CONTEMPORARY URBAN SPACE
- STYLISH HOTEL ROOM
- TRENDY ROOFTOP BAR

SURFACE RANGE & TECHNICAL SPECIFICATIONS >

ENJOY THE VIDEO ▶



Surface Range & Technical Specification

- ↔ PORCELAIN TILES: A SAFE CHOICE
- ↔ SENSITECH TECHNOLOGY
- ↔ BOOST MINERAL RANGE
- ↔ TECHNICAL SPECIFICATIONS

THE INSPIRATION >

IMAGE GALLERY >

SURFACE RANGE & TECHNICAL SPECIFICATIONS >

PORCELAIN TILES:
A SAFE CHOICE

SENSITECH TECHNOLOGY

BOOST MINERAL RANGE

TECHNICAL SPECIFICATION

ENJOY THE VIDEO ▶

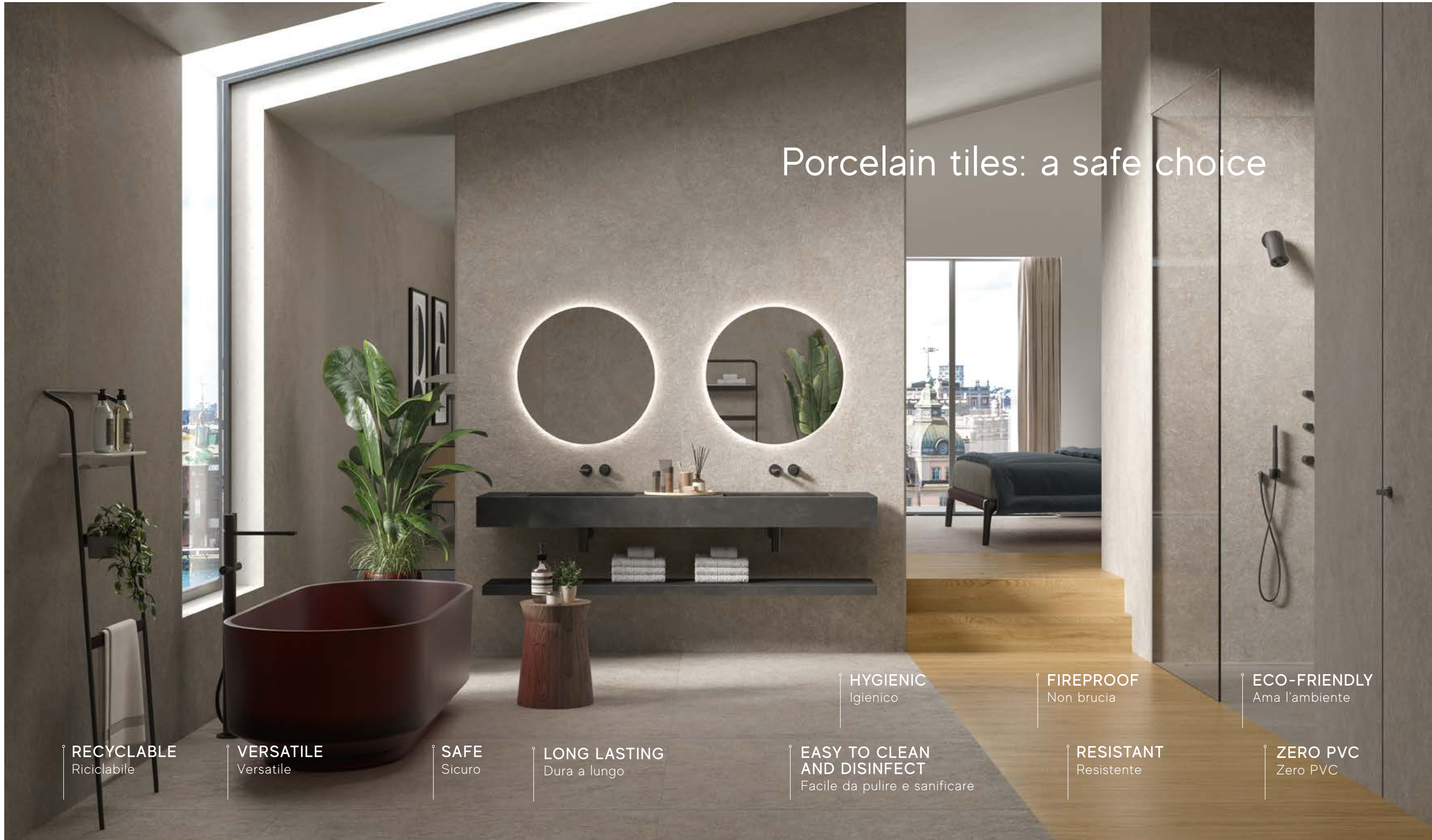

Porcelain tiles: a safe choice

RECYCLABLE
Riciclabile

VERSATILE
Versatile

SAFE
Sicuro

LONG LASTING
Dura a lungo

EASY TO CLEAN AND DISINFECT
Facile da pulire e sanificare

HYGIENIC
Igienico

FIREPROOF
Non brucia

RESISTANT
Resistente

ECO-FRIENDLY
Ama l'ambiente

ZERO PVC
Zero PVC

THE INSPIRATION >

IMAGE GALLERY >

SURFACE RANGE & TECHNICAL SPECIFICATIONS >

PORCELAIN TILES:
A SAFE CHOICE
SENSITECH TECHNOLOGY
BOOST MINERAL RANGE
TECHNICAL SPECIFICATION

ENJOY THE VIDEO

The evolution of ceramic surfaces

Sensitech is the high-tech surface for indoor and outdoor settings created by Atlas Concorde Laboratories. The surface combines high slip resistance performance with tactile softness. With Sensitech, the meaning of surface evolves and takes on a reassuring, pleasant and practical touch, making architectural spaces more comfortable and appealing.

Sensitech è la superficie ad alto coefficiente tecnologico per gli ambienti interni ed esterni realizzata dai Laboratori Atlas Concorde. La superficie coniuga elevate prestazioni di resistenza allo scivolamento ad una maggiore morbidezza tattile. Con Sensitech il significato di superficie si evolve e assume un tocco rassicurante, piacevole e pratico, rendendo gli spazi architettonici sempre più confortevoli e appaganti.

Sensitech est la surface hautement technologique conçue par les laboratoires Atlas Concorde pour les espaces intérieurs et extérieurs. Elle associe des performances de résistance au glissement élevées à une plus grande douceur au toucher. Avec Sensitech, la définition de surface évolue et acquiert un aspect rassurant, agréable et pratique, rendant ainsi les espaces architecturaux de plus en plus confortables.

Sensitech ist die High-Tech-Oberfläche für Innen- und Außenbereiche, die von den Laboratorien Atlas Concorde realisiert wurden. Die Oberfläche kombiniert hohe Rutschfestigkeit mit taktilem Weichheit. Mit Sensitech entwickelt sich die Bedeutung der Oberfläche weiter und erhält einen beruhigenden, angenehmen und praktischen Touch, der architektonische Räume komfortabler gestaltet.

Sensitech es la superficie de alto valor tecnológico para ambientes interiores y exteriores creada por los laboratorios de Atlas Concorde. La superficie combina un alto rendimiento de resistencia al deslizamiento con una mayor suavidad al tacto. Con Sensitech, el significado de superficie evoluciona y adquiere un aire tranquilizador, agradable y práctico, haciendo que los espacios arquitectónicos resulten cada vez más cómodos y agradables.

Sensitech - это высокотехнологичная поверхность для помещений и улицы, созданная лабораториями Atlas Concorde. Она сочетает в себе высокие показатели противоскольжения с высокой тактильной мягкостью. Sensitech трансформирует значение поверхностей, делая их успокаивающими, приятными и практичными, благодаря чему архитектурные пространства становятся удобнее.

Sensitech

SAFE. SOFT. SMART.

INDOOR & OUTDOOR CONTINUITY

SOFT TO THE TOUCH

EXTREMELY SAFE

HYGIENIC AND EASY TO CLEAN

LONG-LASTING QUALITIES

Traditional anti-slip surface

The innovative Sensitech Surface

discover more

The profile of standard anti-slip surfaces has an accentuated alternation of peaks and hollows, which generates friction and increases slip resistance, but also results in very rough surfaces. In Sensitech, special micro-particles fill hollows, leaving the anti-slip performance intact, while the surface is levelled and smoothed. These qualities make cleaning easier because it is less likely to retain dust and dirt.

THE INSPIRATION >

IMAGE GALLERY >

SURFACE RANGE & TECHNICAL SPECIFICATIONS >

PORCELAIN TILES: A SAFE CHOICE

SENSITECH TECHNOLOGY

BOOST MINERAL RANGE

TECHNICAL SPECIFICATION

ENJOY THE VIDEO

Porcelain tiles

PORCELAIN TILES - Gres Porcellanato - Grès cérame - Feinsteinzeug Gres porcelánico - Керамический гранит

RECTIFIED MONOCALIBER - Rettificato monocalibro - Rectifié mono-calibre - Geschliffen einkalibrig - Rectificado monocalibre - Ретифицированный в одном калибре

		White	Pearl	Grey	Smoke	Tarmac
Floor & Wall Furniture	120x278 cm - 47 ¹ / ₄ "x109 ¹ / ₂ " ± 6 mm	Matte *	Matte *	Matte *	Matte *	Matte *
	120x240 cm - 47 ¹ / ₄ "x94 ¹ / ₂ " ± 9 mm	Matte Sensitech *	Matte Sensitech *	Matte Sensitech *	Matte Sensitech *	Matte Sensitech *
	120x120 cm - 47 ¹ / ₄ "x47 ¹ / ₄ " ± 9 mm	Matte Sensitech	Matte Sensitech	Matte Sensitech	Matte Sensitech	Matte Sensitech
	75x150 cm - 29 ¹ / ₂ "x59" ± 9 mm	Matte Sensitech	Matte Sensitech	Matte Sensitech	Matte Sensitech	Matte Sensitech
	75x75 cm - 29 ¹ / ₂ "x29 ¹ / ₂ " ± 9 mm	Matte Sensitech	Matte Sensitech	Matte Sensitech	Matte Sensitech	Matte Sensitech
	60x120 cm - 23 ⁵ / ₈ "x47 ¹ / ₄ " ± 9 mm	Matte Sensitech	Matte Sensitech	Matte Sensitech	Matte Sensitech	Matte Sensitech
	60x60 cm - 23 ⁵ / ₈ "x23 ⁵ / ₈ " ± 9 mm	Matte Sensitech	Matte Sensitech	Matte Sensitech	Matte Sensitech	Matte Sensitech
	30x60 cm - 11 ³ / ₄ "x23 ⁵ / ₈ " ± 9 mm	Matte Sensitech	Matte Sensitech	Matte Sensitech	Matte Sensitech	Matte Sensitech
Countertops Furniture	162x324 cm - 63 ³ / ₄ "x127 ¹ / ₂ " > Non rectified - non rettificato ± 12 mm			Hammered		
Outdoor	60x60 cm - 23 ⁵ / ₈ "x23 ⁵ / ₈ " ± 9 mm	Grip Sensitech	Grip Sensitech	Grip Sensitech	Grip Sensitech	Grip Sensitech
	60x120 cm - 23 ⁵ / ₈ "x47 ¹ / ₄ " ± 9 mm	Grip Sensitech	Grip Sensitech	Grip Sensitech	Grip Sensitech	Grip Sensitech
	120x240 cm - 47 ¹ / ₄ "x94 ¹ / ₂ " ± 20 mm			Outdoor Sensitech *		
	120x120 cm - 47 ¹ / ₄ "x47 ¹ / ₄ " ± 20 mm	Outdoor Sensitech		Outdoor Sensitech	Outdoor Sensitech	Outdoor Sensitech
	60x120 cm - 23 ⁵ / ₈ "x47 ¹ / ₄ " ± 20 mm	Outdoor Sensitech		Outdoor Sensitech	Outdoor Sensitech	Outdoor Sensitech
	60x90 cm - 23 ⁵ / ₈ "x35 ³ / ₈ " ± 20 mm	Outdoor Sensitech		Outdoor Sensitech	Outdoor Sensitech	Outdoor Sensitech
	60x60 cm - 23 ⁵ / ₈ "x23 ⁵ / ₈ " ± 20 mm	Outdoor Sensitech		Outdoor Sensitech	Outdoor Sensitech	Outdoor Sensitech

* Elegant surface

Sensitech

SAFE. SOFT. SMART.

The constant research of Atlas Concorde Laboratories has led to the creation of Sensitech, the porcelain tile surface made using a production method patented in Italy that combines superior slip-resistance with an unprecedented tactile softness, guaranteeing ease of cleaning and maintenance.

Dalla costante ricerca dei Laboratori Atlas Concorde nasce Sensitech, la superficie in gres porcellanato realizzata con metodo produttivo brevettato in Italia, che associa elevate prestazioni di resistenza allo scivolamento ad un'inedita morbidezza tattile, garantendo facilità di pulizia e manutenzione.

Destination of use

Matte ± 6 mm	Matte Sensitech ± 9 mm Grip Sensitech ± 9 mm Outdoor Sensitech ± 20 mm
--------------	--

Anti-slip

R9 Matte ± 6 mm
R10 B Matte Sensitech ± 9 mm
R11 C Grip Sensitech ± 9 mm
R11 C Outdoor Sensitech ± 20 mm

Color-shading

V3 Moderate Variation
All colors

pag.110

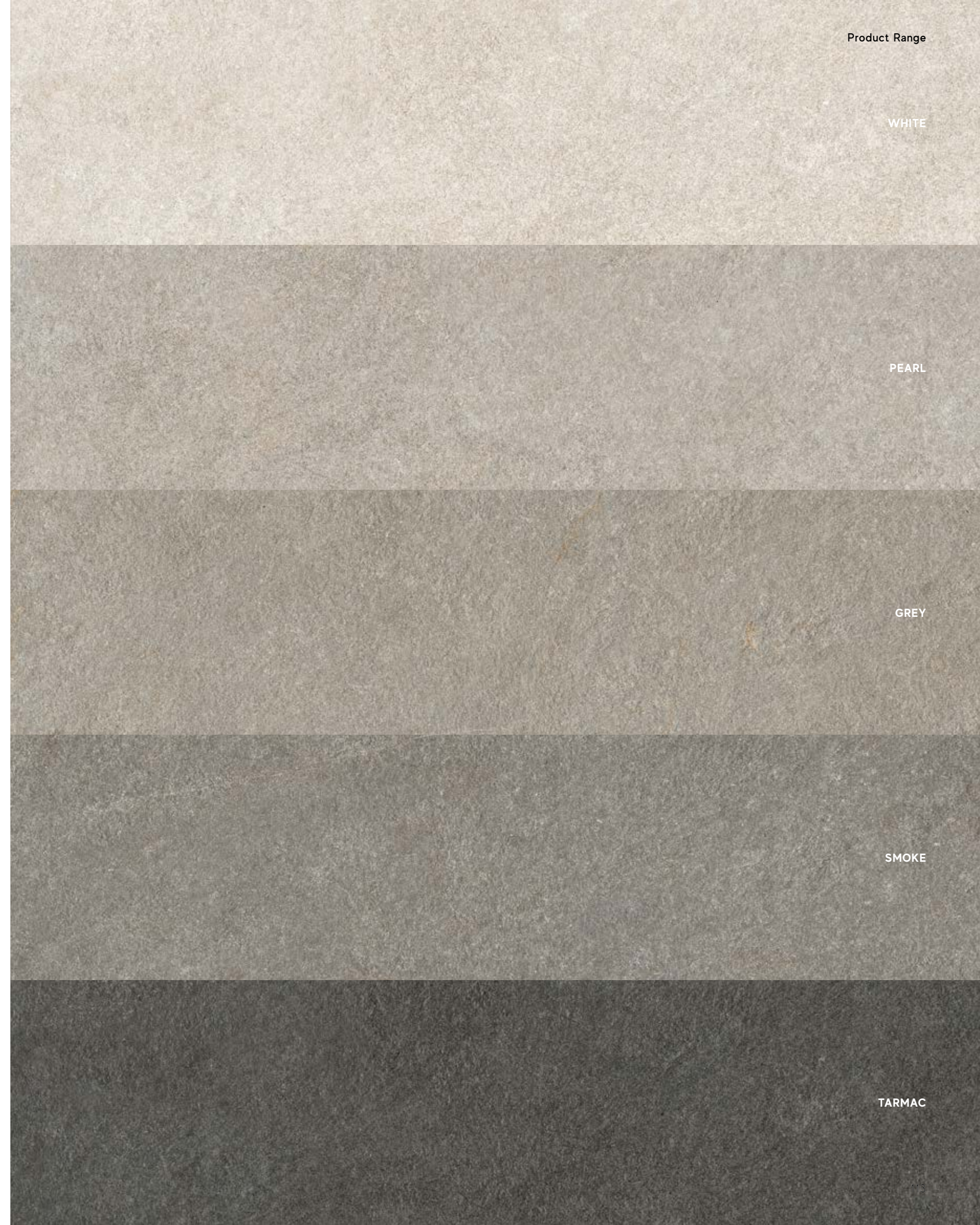

THE INSPIRATION >

IMAGE GALLERY >

SURFACE RANGE & TECHNICAL SPECIFICATIONS >

PORCELAIN TILES:
A SAFE CHOICE
SENSITECH TECHNOLOGY
BOOST MINERAL RANGE
TECHNICAL SPECIFICATION

ENJOY THE VIDEO

TARMAC

Porcelain Tiles Decors



Boost Mineral White
Venus Lux (*)
60x120 cm - 23⁵/₈"x47¹/₄"



Boost Mineral Pearl
Venus Lux (*)
60x120 cm - 23⁵/₈"x47¹/₄"



Boost Mineral Grey
Venus Lux (*)
60x120 cm - 23⁵/₈"x47¹/₄"



Boost Mineral Smoke
Venus Lux (*)
60x120 cm - 23⁵/₈"x47¹/₄"



Boost Mineral Tarmac
Venus Lux (*)
60x120 cm - 23⁵/₈"x47¹/₄"

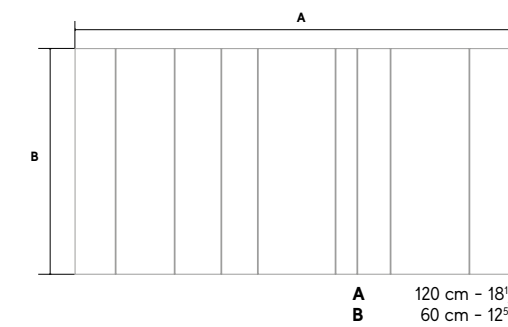

A 120 cm - 18¹/₄"
B 60 cm - 12⁵/₈"



(*) Engraved mosaic. For best results it is advisable to completely plaster the engravings. Application of decorative materials. The use of a common mild detergent is recommended. Avoid using acidic or alkaline products, waxes, steel wool, or abrasives. / Mosaico inciso, per risultato ottimale si consiglia di stuccare completamente le incisioni. Applicazione di materie decorative. Si consiglia l'utilizzo di un comune detergente neutro. Evitare l'utilizzo di prodotti acidi o alcalini, ceranti e pagliette di metallo o abrasive. / Mosaïque gravée; pour de meilleurs résultats, il est recommandé de remplir complètement les gravures. Application de matériaux décoratifs. Nous conseillons l'emploi de détergents neutres courants. Éviter l'utilisation de cires et de produits acides ou alcalins, ainsi que les pailles métalliques ou abrasives. / Graviertes Mosaik; für ein optimales Resultat sollten die Gravuren vollständig verspachtelt werden. Dekorationsmaterial. Es empfiehlt sich, ein haushaltsübliches, neutrales Reinigungsmittel zu verwenden. Saure oder alkalische Produkte, Wachs sowie Stahlwolle- bzw. Scheuerschwämme sind zu vermeiden. / Mosaico grabado, para obtener los mejores resultados se recomienda enmasillar el grabado en su totalidad. Aplicación de materiales decorativos. Recomendamos utilizar un detergente neutro común. Hay que evitar el uso de productos ácidos o alcalinos, ceras y estropajos de metal o abrasivos. / Высеченная мозаика. Для оптимального результата рекомендуется полностью заделать углубления затиркой. Применение декоративных материалов. Рекомендуется чистить обычным нейтральным моющим средством. Не рекомендуется использовать кислотные, щелочные, восковые средства, а также металлические мочалки.

THE INSPIRATION >

IMAGE GALLERY >

SURFACE RANGE & TECHNICAL SPECIFICATIONS >

PORCELAIN TILES:
A SAFE CHOICE

SENSITECH TECHNOLOGY

BOOST MINERAL RANGE

TECHNICAL SPECIFICATION

ENJOY THE VIDEO

Porcelain Tiles Decors



Boost Mineral White
Mosaico Matte
30x30 cm - 11³/₄"x11³/₄"



Boost Mineral Pearl
Mosaico Matte
30x30 cm - 11³/₄"x11³/₄"

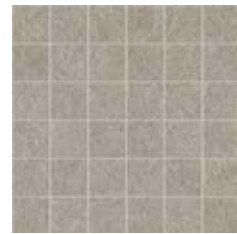

Boost Mineral Grey
Mosaico Matte
30x30 cm - 11³/₄"x11³/₄"

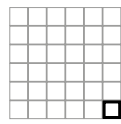

4,75x4,75 cm
1³/₈"x1³/₈"

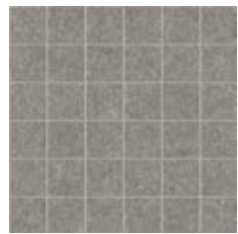

Boost Mineral Smoke
Mosaico Matte
30x30 cm - 11³/₄"x11³/₄"

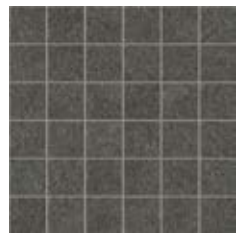

Boost Mineral Tarmac
Mosaico Matte
30x30 cm - 11³/₄"x11³/₄"



Boost Mineral White
Domino Lux (*)
35x29,2 cm - 13³/₄"x11¹/₂"



Boost Mineral Pearl
Domino Lux (*)
35x29,2 cm - 13³/₄"x11¹/₂"



Boost Mineral Grey
Domino Lux (*)
35x29,2 cm - 13³/₄"x11¹/₂"

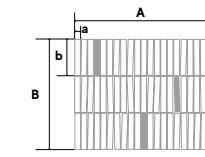

A 34,951 cm - 18¹/₄"
a 1,5 cm - 18¹/₄"
B 29,21 cm - 12⁵/₈"
b 9,6 cm - 7¹/₂"



Boost Mineral Smoke
Domino Lux (*)
35x29,2 cm - 13³/₄"x11¹/₂"

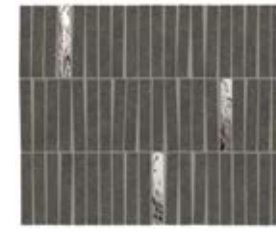

Boost Mineral Tarmac
Domino Lux (*)
35x29,2 cm - 13³/₄"x11¹/₂"



Boost Mineral White
Brick
30x60 cm - 11³/₄"x23⁵/₈"



Boost Mineral Pearl
Brick
30x60 cm - 11³/₄"x23⁵/₈"



Boost Mineral Grey
Brick
30x60 cm - 11³/₄"x23⁵/₈"



Boost Mineral Smoke
Brick
30x60 cm - 11³/₄"x23⁵/₈"



Boost Mineral Tarmac
Brick
30x60 cm - 11³/₄"x23⁵/₈"

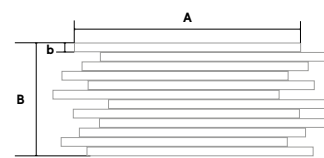

A 59,5 cm - 18¹/₄"
B 29,65 cm - 12⁵/₈"
b 2,3 cm - 7¹/₂"



(*) Application of decorative materials. The use of a common mild detergent is recommended. Avoid using acidic or alkaline products, waxes, steel wool, or abrasives. / Applicazione di materie decorative. Si consiglia l'utilizzo di un comune detergente neutro. Evitare l'utilizzo di prodotti acidi o alcalini, ceranti e pagliette di metallo o abrasive. / Application de matériaux décoratifs. Nous conseillons l'emploi de détergents neutres courants. Éviter l'utilisation de cires et de produits acides ou alcalins, ainsi que les pailles métalliques ou abrasives. / Dekorationsmaterial. Es empfiehlt sich, ein haushaltsübliches, neutrales Reinigungsmittel zu verwenden. Saure oder alkalische Produkte, Wachs sowie Stahlwolle- bzw. Scheuerschwämme sind zu vermeiden. / Aplicación de materiales decorativos. Recomendamos utilizar un detergente neutro común. Hay que evitar el uso de productos ácidos o alcalinos, ceras y estropajos de metal o abrasivos. / Применение декоративных материалов. Рекомендуется чистить обычным нейтральным моющим средством. Не рекомендуется использовать кислотные, щелочные, восковые средства, а также металлические мочалки.

THE INSPIRATION >

IMAGE GALLERY >

SURFACE RANGE & TECHNICAL SPECIFICATIONS >

PORCELAIN TILES:
A SAFE CHOICE
SENSITECH TECHNOLOGY
BOOST MINERAL RANGE
TECHNICAL SPECIFICATION

ENJOY THE VIDEO

Porcelain Tiles Decors



Boost Mineral White
Slice A+B (*)
60x120 cm - 23⁵/₈"x47¹/₄" ± 20 mm

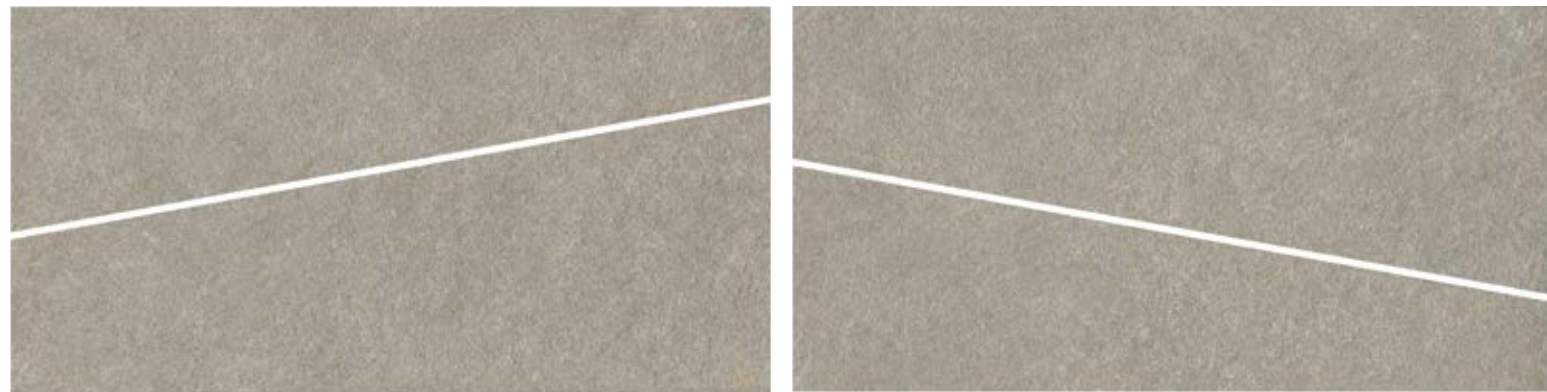

Boost Mineral Grey
Slice A+B (*)
60x120 cm - 23⁵/₈"x47¹/₄" ± 20 mm



Boost Mineral Smoke
Slice A+B (*)
60x120 cm - 23⁵/₈"x47¹/₄" ± 20 mm

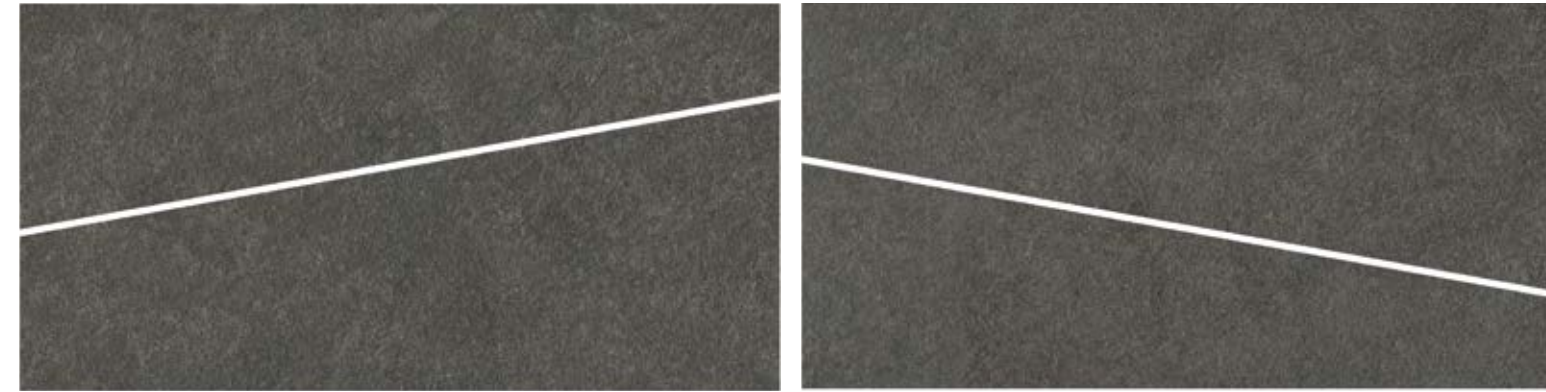

Boost Mineral Tarmac
Slice A+B (*)
60x120 cm - 23⁵/₈"x47¹/₄" ± 20 mm

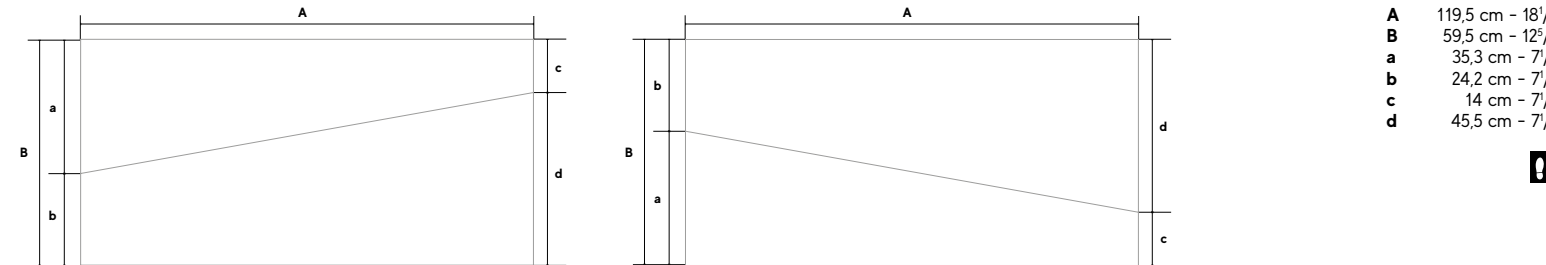

(*) We recommend "dry" installation on gravel and/or grass. / Si consiglia posa "a secco" su ghiaia e/o erba. / Pose « à sec » sur gravillons et/ou herbe conseillée. / Es wird eine Trockenverlegung auf Kies bzw. Rasen empfohlen. / Se recomienda colocación «en seco» sobre grava o hierba. / Рекомендуется «сухая» укладка на гравий и/или траву.

THE INSPIRATION >

IMAGE GALLERY >

SURFACE RANGE & TECHNICAL SPECIFICATIONS >

PORCELAIN TILES:
A SAFE CHOICE
SENSITECH TECHNOLOGY
BOOST MINERAL RANGE
TECHNICAL SPECIFICATION

ENJOY THE VIDEO

Trim tiles

Indoor trim tiles

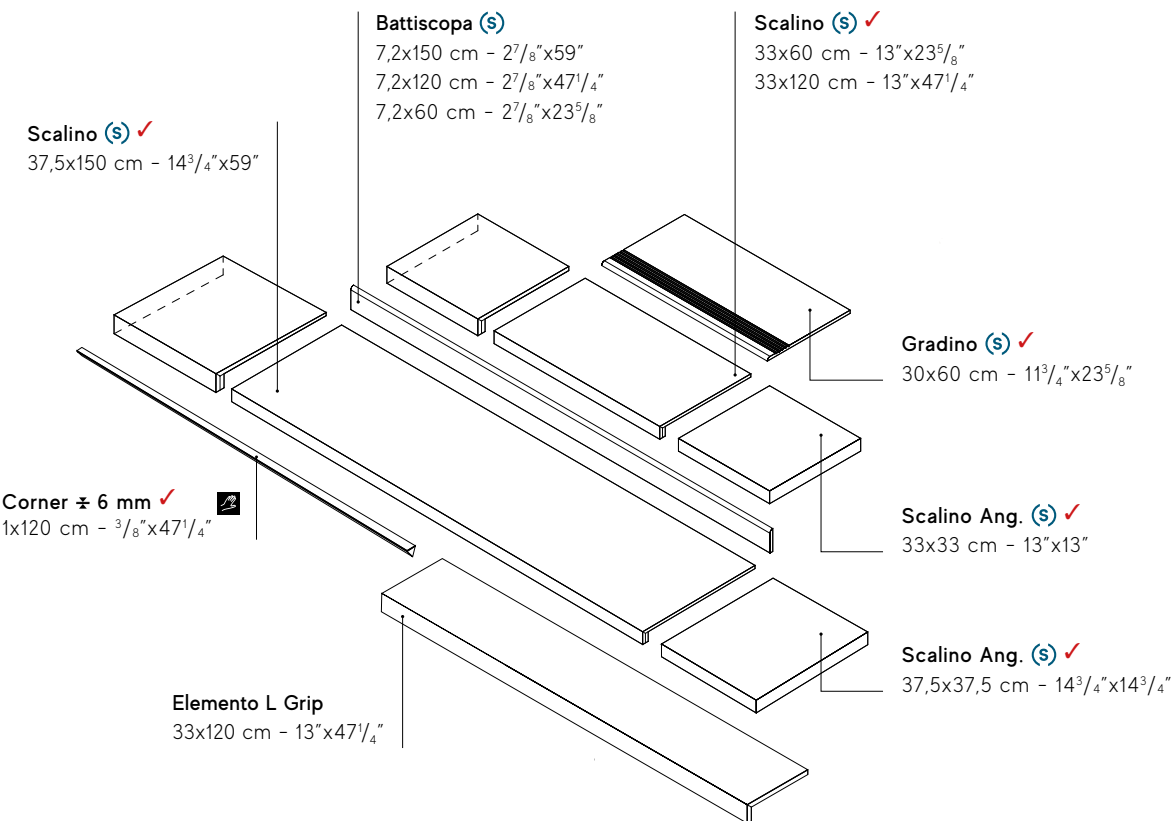

Outdoor trim tiles ± 20 mm

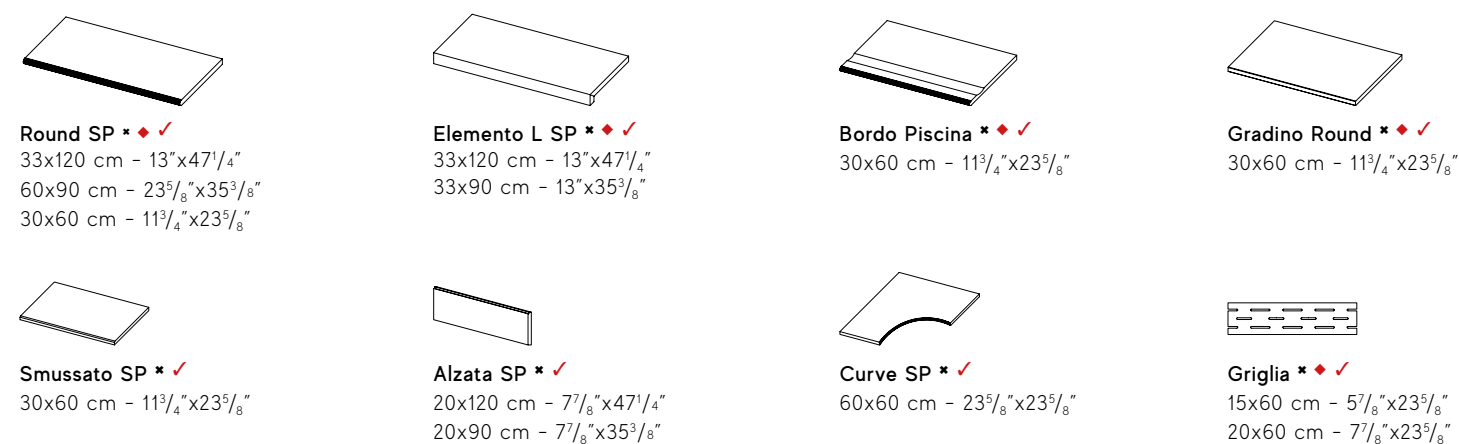

- * Available in / Disponibile in White, Grey, Smoke, Tarmac
- ✓ These parts are supplied to order / I pezzi sono disponibili su ordinazione
- ♦ Right-left angular elements are available / Sono disponibili gli elementi angolari dx/sx

Outdoor Porcelain tiles ± 20 mm

For further details on the 20mm thick products, related trim pieces and installation systems - in particular for recommendations and precautions during installation- please refer to the Outdoor Design section on the Atlas Concorde website or to the Outdoor Design catalogue. Per dettagli sul prodotto e sui relativi pezzi speciali in 20mm di spessore, per i sistemi di posa e, in particolare, per raccomandazioni, accorgimenti e precauzioni in fase di posa e progettazione, si raccomanda di prendere visione del catalogo Outdoor Design e della sezione Outdoor Design del sito Atlas Concorde. - Pour plus de renseignements sur le produit, les pièces spéciales de 20mm d'épaisseur et sur les systèmes de pose, ainsi que pour tous conseils et recommandations et précautions d'emploi pendant la pose ou en phase de conception, nous vous recommandons de lire le catalogue Outdoor Design et de consulter la section Outdoor Design sur le site d'Atlas Concorde. - Bitte beachten Sie die detaillierten Informationen zum Produkt und zu den zugehörigen Formteilen in 20mm Stärke, zu den Verlegesystemen sowie vor allem die Empfehlungen, Tipps und bei der Planung und Verlegung zu beachtenden Vorsichtsmaßnahmen, die im Katalog Outdoor Design und im Bereich Outdoor Design der Atlas Concorde-Website aufgeführt sind. - Para mayor información sobre el producto y sus relativas piezas especiales de 20mm de grosor, para los sistemas de colocación, y en particular, para las recomendaciones, cautelas y precauciones en la fase de colocación y diseño, se recomienda consultar el catálogo Outdoor Design y la sección Outdoor Design del sitio Atlas Concorde. - Подробнее о плитках и о специальных элементах толщиной 20мм, о системах монтажа, о мерах предосторожности при проектировании и укладке можно узнать в каталоге Outdoor Design и в разделе Outdoor Design на сайте Atlas Concorde.



Porcelain tiles - Rectified monocaliber

Gres porcellanato - Rettificato monocalibro

Compliant with standards EN 14411 annex G group Bla	120x278 cm - 47 ¹ / ₄ "x109 ¹ / ₂ "	± 6 mm	60x120 cm - 23 ⁵ / ₈ "x47 ¹ / ₄ "	± 9, 20 mm
Compliant with standards ISO 13006 annex G group Bla	120x240 cm - 47 ¹ / ₄ "x94 ¹ / ₂ "	± 9, 20 mm	60x90 cm - 23 ⁵ / ₈ "x35 ³ / ₈ "	± 20 mm
Conforme alla norma EN 14411 Appendice G gruppo Bla	120x120 cm - 47 ¹ / ₄ "x47 ¹ / ₄ "	± 9, 20 mm	60x60 cm - 23 ⁵ / ₈ "x23 ⁵ / ₈ "	± 9, 20 mm
Conforme alla norma ISO 13006 Appendice G gruppo Bla	75x150 cm - 29 ¹ / ₂ "x59"	± 9 mm	30x60 cm - 11 ³ / ₄ "x23 ⁵ / ₈ "	± 9 mm
	75x75 cm - 29 ¹ / ₂ "x29 ¹ / ₂ "	± 9 mm		

Technical features Caratteristiche tecniche	Test Method Metodo di prova	Requirements for nominal size N / Requisiti per dimensione nominale N			Porcelain tiles			
		7 cm ≤ N < 15 cm	N ≥ 15 cm		Matte, Matte Sensitech ± 9 mm	Matte ± 6 mm	Grip Sensitech ± 9 mm	Outdoor Sensitech ± 20 mm
Length and width Lunghezza e larghezza	ISO 10545-2	± 0,9 (*) Non-rect. ± 0,4 (*) Rect.	± 0,6 (*) Non-rect. ± 0,3 (*) Rect.	± 2,0 (*) Non-rect. ± 1,0 (*) Rect.	Suitable for Conforme	Suitable for Conforme	Suitable for Conforme	Suitable for Conforme
Thickness Spessore		± 0,5 (**)	± 5 (**)	± 0,5 (**)	Suitable for Conforme	Suitable for Conforme	Suitable for Conforme	Suitable for Conforme
Straightness of sides Rettilinearità degli spigoli		± 0,8 (***) Non-rect. ± 0,4 (***) Rect.	± 0,5 (***) Non-rect. ± 0,3 (***) Rect.	± 1,5 (***) Non-rect. ± 0,8 (***) Rect.	Suitable for Conforme	Suitable for Conforme	Suitable for Conforme	Suitable for Conforme
Rectangularity Ortogonalità	ISO 10545-2	± 0,8 (****) Non-rect. ± 0,4 (****) Rect.	± 0,5 (****) Non-rect. ± 0,3 (****) Rect.	± 2,0 (****) Non-rect. ± 1,5 (****) Rect.	Suitable for Conforme	Suitable for Conforme	Suitable for Conforme	Suitable for Conforme
Surface flatness Planarità		c.c. ± 0,8 Non-rect. c.c. ± 0,6 Rect.	c.c. ± 0,5 Non-rect. c.c. ± 0,4 Rect.	c.c. ± 2,0 Non-rect. c.c. ± 1,8 Rect.	Suitable for Conforme	Suitable for Conforme	Suitable for Conforme	Suitable for Conforme
Water absorption (in % by mass) Massa d'acqua assorbita (come % della massa)		ISO 10545-3	E _v ≤ 0,5% Individual Maximum 0,6% E _v ≤ 0,5% Valore massimo singolo 0,6%			≤ 0,1 %	≤ 0,1 %	≤ 0,1 %
Breaking strength Sforzo di rottura	ASTM C373-18	Requirement ANSI A1371 Water absorption max ≤ 0,5%			≤ 0,5 %	≤ 0,5 %	≤ 0,5 %	≤ 0,5 %
Modulus of rupture Resistenza alla flessione	ISO 10545-4	S ≥ 700N (for thickness < 7,5 mm - per spessore < 7,5 mm) S ≥ 1300N (for thickness ≥ 7,5 mm - per spessore ≥ 7,5 mm)			S ≥ 40 N/mm ²	S ≥ 40 N/mm ²	S ≥ 40 N/mm ²	S ≥ 45 N/mm ²
Bending strength and breaking load Resistenza a flessione e al carico di rottura (4)(5)	EN 1339 Annex F	-			-	-	-	>=T11 120x120-60x60 >=U4 60x120
Impact resistance, as coefficient of restitution Resistenza all'impatto, espresso come coefficiente di restituzione	ISO 10545-5	Declared value Valore dichiarato			≥ 0,55	≥ 0,55	≥ 0,55	≥ 0,55
Resistance to deep abrasion of unglazed tiles (removed volume) Resistenza all'abrasione profonda delle piastrelle non smaltate (volume materiale asportato)	ISO 10545-6	≤ 175 mm ³			≤ 150 mm ³	≤ 150 mm ³	≤ 150 mm ³	≤ 150 mm ³
Coefficient of thermal linear expansion Coefficiente di dilatazione termica lineare	ISO 10545-8	Declared value Valore dichiarato			≤ 7MK ⁻¹	≤ 7MK ⁻¹	≤ 7MK ⁻¹	≤ 7MK ⁻¹
Thermal shock resistance Resistenza agli sbalzi termici	ISO 10545-9	Pass according to EN ISO 10545-1 Test superato in accordo con ISO 10545-1			Resistant Resiste	Resistant Resiste	Resistant Resiste	Resistant Resiste
Moisture expansion (in mm/m) Dilatazione all'umidità (in mm/m)	ISO 10545-10	Declared value Valore dichiarato			≤ 0,01% (0,1mm/m)	≤ 0,01% (0,1mm/m)	≤ 0,01% (0,1mm/m)	≤ 0,01% (0,1mm/m)
Frost resistance Resistenza al gelo	ISO 10545-12	Pass according to EN ISO 10545-1 Test superato in accordo con ISO 10545-1			Resistant Resiste	Resistant Resiste	Resistant Resiste	Resistant Resiste
Bond strength/adhesion for improved cementitious adhesives Adesione a trazione con adesivi cementizi migliorati	EN 1348	Declared value Valore dichiarato			≥ 1,0 N/mm ² (Class C2 - EN 12004)	≥ 1,0 N/mm ² (Class C2 - EN 12004)	≥ 1,0 N/mm ² (Class C2 - EN 12004)	≥ 1,0 N/mm ² (Class C2 - EN 12004)
Reaction to fire Reazione al fuoco	-	Class A1 or A1 _s Classe A1 oppure A1 _s			A1 - A1 _s	A1 - A1 _s	A1 - A1 _s	A1 - A1 _s
Resistance to household chemicals and swimming pool salts Resistenza ai prodotti chimici di uso domestico e agli additivi per piscina	ISO 10545-13	Minimum Class B Classe minima B			A	A	A	A
Resistance to low concentrations of acids and alkalis Resistenza a basse concentrazioni di acidi e alcali		Declared Class Classe dichiarata			LA	LA	LA	LA
Resistance to high concentrations of acids and alkalis Resistenza ad alte concentrazioni di acidi e alcali		Declared Class Classe dichiarata			HA	HA	HA	HA
Resistance to staining, for unglazed tiles Resistenza alle macchie per piastrelle non smaltate	ISO 10545-14	Declared Class Classe dichiarata			5	5	5	5
Shoold Ramp Test Metodo della rampa "calzato"	EN 16165 ANNEX B (EX DIN 51130)	Declared value Valore dichiarato			R10	R9	R11	R11
Barefoot Ramp Test Metodo della rampa a piedi nudi	EN 16165 ANNEX A (EX DIN 51097)	Declared value Valore dichiarato			A+B	A	A+B+C	A+B+C
Pendulum Friction Test Metodo del Pendolo	EN 16165 ANNEX C (EX BS 7976)	PTV ≥ 36 classifies the surface as "low slip risk"			≥ 36 Dry ≥ 36 Wet	(*)	≥ 36 Dry ≥ 24 Wet	≥ 36 Dry ≥ 36 Wet
Coefficient of friction (COF) Coefficiente di attrito	B.C.R.A. Rep. CEC/81	Declared Classification of the new pedestrian surface materials according to the Pendulum Test			Class P3	(**)	Class P4	Class P4
		Declared value Valore dichiarato			Class C2	(***)	Class C3	Class C3
Dynamic coefficient of friction (DCOF) Coefficiente di attrito dinamico	ANSI A 326.3	D. M. 236/89 del 14/06/89 μ > 0,40 per elemento scivolante cuoio su pavimentazione asciutta μ > 0,40 per elemento scivolante gomma dura su pavimentazione bagnata			> 0,40 Asciutto > 0,40 Bagnato	> 0,40 Asciutto > 0,40 Bagnato	> 0,40 Asciutto > 0,40 Bagnato	> 0,40 Asciutto > 0,40 Bagnato
		-			wet DCOF ≥ 0,50	dry DCOF ≥ 0,42	dry DCOF ≥ 0,42	wet DCOF ≥ 0,55

(*) The permissible deviation, in % or mm, of the average size for each tile (2 or 4 sides) from work size (WS). Deviazione ammissibile, in % oppure mm, della dimensione media di ogni piastrella (2 oppure 4 lati) dalla dimensione di fabbricazione (WS).
 (**) The permissible deviation, in % or mm, of the average thickness for each tile from the work size thickness (WS). Deviazione ammissibile, in % oppure mm, della spessore medio di ogni piastrella dallo spessore riportato nella dimensione di fabbricazione (WS).
 (***) The maximum permissible deviation from straightness, in % or mm, related to the corresponding work sizes (WS). Deviazione massima ammissibile di rettilineità, in % oppure mm, in rapporto alle dimensioni di fabbricazione (WS) corrispondenti.
 (****) The maximum permissible deviation from rectangularity, in % or mm, related to the corresponding work sizes (WS). Deviazione massima ammissibile di ortogonalità, in % oppure mm, in rapporto alle dimensioni di fabbricazione (WS) corrispondenti.
 c.c. The maximum permissible deviation from centre curvature, in % or mm, related to diagonal calculated from the work sizes (WS). Deviazione massima ammissibile della curvatura del centro, in % oppure mm, in rapporto alla diagonale calcolata secondo le dimensioni di fabbricazione (WS).
 e.c. The maximum permissible deviation from edge curvature, in % or mm, related to the corresponding work sizes (WS). Deviazione massima ammissibile della curvatura dello spigolo, in % oppure mm, in rapporto alle dimensioni di fabbricazione (WS) corrispondenti.
 w. The maximum permissible deviation from warpage, in % or mm, related to diagonal calculated from the work sizes (WS). Deviazione massima ammissibile dello sverglimento, in % oppure mm, in rapporto alla diagonale calcolata secondo le dimensioni di fabbricazione (WS).
 (1) Determination of slip resistance of pedestrian surfaces: it does not cover sports surfaces and road surfaces for vehicles (skid resistance). Determinazione della resistenza allo scivolamento delle superfici pedonabili: non si applica alle pavimentazioni sportive ed alle pavimentazioni stradali veicolari.
 (2) Anti-slip performance is guaranteed at the time of delivery of the product. Le prestazioni anti-slip vengono garantite al momento della consegna del prodotto.
 (3) However, tiles with a DCOF of 0,42 or greater are not necessarily suitable for all projects. The specifier shall determine tiles appropriate for specific project conditions, considering by way of example, but not in limitation, type of use, traffic, expected contaminants, expected maintenance, expected wear, and manufacturers guidelines and recommendations.
 (4) For further details, please refer to outdoor design general catalogue. Per maggiori informazioni riferirsi al catalogo generale Outdoor Design.
 (5) Only for products with 20 mm thickness. Solo per prodotti a 20mm di spessore.
 (*) PTV ≥ 36 Wet on demands. Bagnato su richiesta.
 (***) P3 on demand. Su richiesta.
 (****) C2 on demand. Su richiesta.

THE INSPIRATION

IMAGE GALLERY

SURFACE RANGE & TECHNICAL SPECIFICATIONS

PORCELAIN TILES: A SAFE CHOICE
 SENSITECH TECNOLOGY
 BOOST MINERAL RANGE
 TECHNICAL SPECIFICATION

ENJOY THE VIDEO

BOOSTWORLD

Range Summary

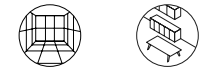
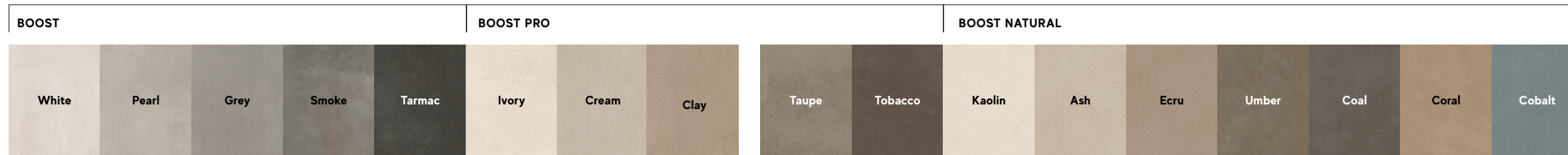

Floor & Wall Furniture

Size	Thickness	White	Pearl	Grey	Smoke	Tarmac	Ivory	Cream	Clay	Taupe	Tobacco	Kaolin	Ash	Ecu	Umber	Coal	Coral	Cobalt	
160x320 cm - 63"x126"	± 6 mm	Matte			Matte	Matte	Matte		Matte	Matte									
160x160 cm - 63"x63"	± 6 mm	Matte			Matte	Matte	Matte		Matte										
120x278 cm - 47 1/4"x109 1/2"	± 6 mm	Matte	Matte	Matte	Matte	Matte	Matte	Matte	Matte	Matte									
120x240 cm - 47 1/4"x94 1/2"	± 9 mm	Matte (S)	Matte (S)	Matte (S)	Matte (S)	Matte (S)	Matte (S)	Matte (S)	Matte (S)	Matte (S)									
120x120 cm - 47 1/4"x47 1/4"	± 6 mm	Matte	Matte	Matte	Matte	Matte	Matte	Matte	Matte	Matte									
	± 9 mm	Matte (S)	Matte (S)	Matte (S)	Matte (S)	Matte (S)	Matte (S)	Matte (S)	Matte (S)	Matte (S)									
75x150 cm - 29 1/2"x59"	± 9 mm	Matte (S)	Matte (S)	Matte (S)	Matte (S)	Matte (S)	Matte (S)	Matte (S)	Matte (S)	Matte (S)									
60x120 cm - 23 5/8"x47 1/4"	± 9 mm	Matte (S)	Matte (S)	Matte (S)	Matte (S)	Matte (S)	Matte (S)	Matte (S)	Matte (S)	Matte (S)									
75x75 cm - 29 1/2"x29 1/2"	± 9 mm	Matte (S)	Matte (S)	Matte (S)	Matte (S)	Matte (S)	Matte (S)	Matte (S)	Matte (S)	Matte (S)									
37,5x75 cm - 14 3/4"x29 1/2"	± 9 mm	Matte (S)	Matte (S)	Matte (S)	Matte (S)	Matte (S)	Matte (S)	Matte (S)	Matte (S)	Matte (S)									
60x60 cm - 23 5/8"x23 5/8"	± 9 mm	Matte (S)	Matte (S)	Matte (S)	Matte (S)	Matte (S)	Matte (S)	Matte (S)	Matte (S)	Matte (S)									
30x60 cm - 11 3/4"x23 5/8"	± 9 mm	Matte (S)	Matte (S)	Matte (S)	Matte (S)	Matte (S)	Matte (S)	Matte (S)	Matte (S)	Matte (S)									



Outdoor

Size	Thickness	White	Pearl	Grey	Smoke	Tarmac	Ivory	Cream	Clay	Taupe	Tobacco	Kaolin	Ash	Ecu	Umber	Coal	Coral	Cobalt	
120x120 cm - 47 1/4"x47 1/4"	± 9 mm	Grip	Grip	Grip	Grip	Grip	Grip	Grip	Grip	Grip									
60x120 cm - 23 5/8"x47 1/4"	± 9 mm										Grip	Grip	Grip	Grip	Grip				
60x60 cm - 23 5/8"x23 5/8"	± 9 mm																		
30x60 cm - 11 3/4"x23 5/8"	± 9 mm																		
120x240 cm - 47 1/4"x94 1/2"	± 20 mm	Outdoor		Outdoor															
120x120 cm - 47 1/4"x47 1/4"	± 20 mm	Outdoor		Outdoor	Outdoor	Outdoor		Outdoor	Outdoor										
60x120 cm - 23 5/8"x47 1/4"	± 20 mm	Outdoor		Outdoor	Outdoor	Outdoor		Outdoor	Outdoor										
90x90 cm - 35 3/8"x35 3/8"	± 20 mm	Outdoor		Outdoor	Outdoor	Outdoor		Outdoor	Outdoor										
60x60 cm - 23 5/8"x23 5/8"	± 20 mm	Outdoor		Outdoor	Outdoor	Outdoor		Outdoor	Outdoor										



Countertops Furniture

Size	Thickness	White	Pearl	Grey	Smoke	Tarmac	Ivory	Cream	Clay	Taupe	Tobacco	Kaolin	Ash	Ecu	Umber	Coal	Coral	Cobalt	
162x324 cm - 63 3/4"x127 1/2"	± 12 mm	Hammered			Hammered	Hammered	Hammered							Hammered					
> Non rectified - non rettificato	± 20 mm				Hammered														

Size	Thickness	White	Pearl	Grey	Smoke	Sage	Red	Ivory	Cream	Clay	Mustard	Powder Blue	Kaolin	Ash	Ecu
40x80 cm - 15 3/4"x31 1/2"	± 8,5 mm	Matte	Matte	Matte	Matte	Matte	Matte	Matte	Matte	Matte	Matte	Matte			
40x80 cm - 15 3/4"x31 1/2" 3D Urban	± 10 mm	Matte	Matte	Matte				Matte			Matte				
50x120 cm - 19 5/8"x47 1/4"	± 8,5 mm											Matte	Matte	Matte	
50x120 cm - 19 5/8"x47 1/4" 3D Brushed	± 8,5 mm											Matte	Matte	Matte	
50x120 cm - 19 5/8"x47 1/4" 3D Texture	± 8,5 mm											Matte	Matte	Matte	
50x120 cm - 19 5/8"x47 1/4" 3D Wave	± 8,5 mm											Matte	Matte	Matte	



Wall

Size	Thickness	White	Pearl	Grey	Smoke	Sage	Red	Ivory	Cream	Clay	Mustard	Powder Blue	Kaolin	Ash	Ecu
40x80 cm - 15 3/4"x31 1/2"	± 8,5 mm	Matte	Matte	Matte	Matte	Matte	Matte	Matte	Matte	Matte	Matte	Matte			
40x80 cm - 15 3/4"x31 1/2" 3D Urban	± 10 mm	Matte	Matte	Matte				Matte			Matte				
50x120 cm - 19 5/8"x47 1/4"	± 8,5 mm											Matte	Matte	Matte	
50x120 cm - 19 5/8"x47 1/4" 3D Brushed	± 8,5 mm											Matte	Matte	Matte	
50x120 cm - 19 5/8"x47 1/4" 3D Texture	± 8,5 mm											Matte	Matte	Matte	
50x120 cm - 19 5/8"x47 1/4" 3D Wave	± 8,5 mm											Matte	Matte	Matte	

THE INSPIRATION >

IMAGE GALLERY >

SURFACE RANGE & TECHNICAL SPECIFICATIONS >

PORCELAIN TILES:
A SAFE CHOICE
SENSITECH TECHNOLOGY
BOOST MINERAL RANGE

TECHNICAL SPECIFICATION

ENJOY THE VIDEO >



THANKS TO



Note
 For information and details relating to codes, packaging and weight it is recommended to refer to the latest pricelist. / Per le informazioni e i dati relativi a codici, imballaggi e pesi occorre sempre consultare l'ultimo listino aggiornato e in vigore. / Pour toutes informations et renseignements concernant les codes, les emballages et les poids, il y a toujours lieu de consulter le dernier tarif en vigueur et mis à jour. / Für Informationen und Daten die den Code, die Verpackung und das Gewicht betreffen bitte die aktuellste Preisliste zugrunde legen. / Para acceder a la información y a los datos relativos a códigos, embalajes y pesos hay que consultar siempre la última lista de precios actualizada y vigente. / Для информации о кодах, упаковках и весе обращайтесь к последнему действующему прайс-листу.
 Colors and optical features of the materials illustrated in this catalogue are to be regarded as mere indications. / I colori e le caratteristiche estetiche dei materiali illustrati nel presente catalogo sono da ritenersi puramente indicativi. / Les coloris et les caractéristiques esthétiques des références illustrées dans le catalogue sont donnés à titre purement indicatif. / Die Farben und die ästhetischen Eigenschaften der in diesem Katalog abgebildeten Produkte sind als reine Richtwerte zu betrachten. / Los colores y las características estéticas de los materiales ilustrados en el presente catálogo deben ser considerados como puramente indicativos. / Цвета и эстетические характеристики описанных в настоящем каталоге материалов являются только ориентировочными.
 Atlas Concorde reserves the right to modify any product without notice and will not be liable for any direct or indirect damage resulting from such modifications. / Atlas Concorde si riserva di modificare i prodotti senza preavviso, declinando ogni responsabilità su eventuali danni diretti o indiretti derivanti da eventuali modifiche. / Atlas Concorde se réserve le droit de modifier ses produits sans préavis et décline toute responsabilité concernant les éventuels dommages directs ou indirects qui pourraient dériver de ces modifications. / Atlas Concorde behält sich das Recht vor jederzeit und ohne vorherige Ankündigung, die Produkte zu verändern, und lehnt jede Haftung bei direkten oder indirekten Schäden ab, die von diesen Veränderungen herrühren. / Atlas Concorde se reserva el derecho de modificar los productos sin previo aviso, rechaza cualquier responsabilidad sobre eventuales daños directos o indirectos derivados de eventuales modificaciones. / Atlas Concorde оставляет за собой право изменять характеристики изделий без предварительного уведомления, отклоняя при этом любую ответственность за прямые или косвенные убытки, возникшие в результате изменений.

Ethical identity



For Atlas Concorde, being Made in Italy is not just a prestigious certification of style, design, and production excellence, but an identity that involves all aspects of its business. For this reason, we identify with the values expressed by Confindustria Ceramica's ethical code, which guarantee absolute compliance with labor regulations, and with the marks Made in Italy and Ceramics of Italy, which certify the quality of authentic Italian style.

Per Atlas Concorde, Made in Italy non è solo un prestigioso attestato di stile, design ed eccellenza produttiva, ma un modo di essere che coinvolge tutti gli aspetti della propria attività. Per questo ci riconosciamo nei valori espressi dal codice etico di Confindustria Ceramica, che garantiscono il rispetto assoluto delle normative sul lavoro, e nei marchi Made in Italy e Ceramics of Italy, che certificano la qualità dell'autentico stile italiano.

Certifications

Certifications

<p>Company / Azienda</p>	<p>Product / Prodotto</p>	<p>Product "Declarations" / Dichiarazioni di prodotto</p>
--------------------------	---------------------------	---

Certifications for export to international markets*

--	--	--	--	--	--	--

* Shipments can be made in accordance with national requirements anywhere in the world, even in markets with complex customs procedures such as Egypt, Morocco and Kurdistan, thanks to our active cooperation with accredited certification bodies in each country. - Possibilità di spedizioni conformi alle prescrizioni nazionali ovunque nel mondo, anche in mercati con procedure doganali complesse come Egitto, Marocco, Kurdistan, grazie alla collaborazione sempre attiva con gli enti di certificazione accreditati in ciascun paese. - Dank unserer aktiven Zusammenarbeit mit den akkreditierten Zertifizierungsstellen in den einzelnen Ländern können die Sendungen in Übereinstimmung mit den nationalen Anforderungen überall auf der Welt versandt werden, selbst auf Märkten mit komplexen Zollverfahren wie Ägypten, Marokko und Kurdistan. - Possibilit  d'exp ditions conformes aux prescriptions nationales partout dans le monde, m me sur les march s dont les proc dures douani res sont complexes comme l' gypte, le Maroc ou le Kurdistan, gr ce   la collaboration toujours active avec les organismes de certification homologu s dans chaque pays. - Se pueden realizar env os seg n la normativa nacional a cualquier parte del mundo, incluso a mercados con procedimientos aduaneros complejos como Egipto, Marruecos o Kurdistan, gracias a la cooperaci n permanente con los organismos de certificaci n acreditados en cada pa s. - Компания имеет возможность осуществлять поставки в любую точку мира в соответствии с национальными требованиями, даже на рынках со сложными таможенными процедурами, таких как Египет, Марокко, Курдистан, благодаря неизменно активному сотрудничеству с аккредитованными органами сертификации в каждой стране.

 * Classificazione UPEC aggiornata al - Classement UPEC mis   jour au: 2023
 * Si consiglia la consultazione della pagina - On vous conseille de vous connecter  : https://database.cstb.fr/holderdetails?UId=ETB-2094&AppRef=QB32
 * Per ulteriori informazioni scrivere a - Pour tous renseignements compl mentaires merci d' crire  : france@atlasconcorde.it

THE INSPIRATION >

IMAGE GALLERY >

SURFACE RANGE & TECHNICAL SPECIFICATIONS >

PORCELAIN TILES:
 A SAFE CHOICE
 SENSITECH TECHNOLOGY
 BOOST MINERAL RANGE

TECHNICAL SPECIFICATION

ENJOY THE VIDEO >



Ceramiche Atlas Concorde S.p.A.
Via Canaletto 141
41042 Spezzano di Fiorano (MO) - Italia

Atlas Concorde USA, Inc.
117 Seaboard Lane - Suite F170
Franklin, TN 37067 - USA

Atlas Concorde Russia
Business centre "Meliora Place"
Prospekt Mira 6
129090 Moscow - Russia

Atlas Concorde Middle East, Fz-LLc
Building 8 - Suite 106
D3 Dubai Design District
United Arab Emirates

atlasconcorde.com

Copyright 2023 by Ceramiche Atlas Concorde S.p.A
(41042 Spezzano di Fiorano (MO) - Italia)
April 2023